

# Agilent IO Libraries Installation and Configuration Guide for Windows





# Contents

## IO Libraries Installation and Configuration Guide for Windows

---

<b>Front Matter</b> .....	<b>5</b>
Notice .....	5
Warranty Information .....	5
U.S. Government Restricted Rights .....	5
Trademark Information .....	6
Printing History .....	6
Copyright Information .....	6
<b>1. Introducing the IO Libraries</b> .....	<b>7</b>
Using This Guide .....	9
What's in This Guide? .....	9
If You Need Help .....	9
IO Libraries Overview .....	10
Agilent VISA Description .....	10
Agilent SICL Description .....	12
IO Config Description .....	13
VISA Assistant Description .....	13
VXI Resource Manager Description .....	14
LAN Server Description .....	14
<b>2. Installing the IO Libraries</b> .....	<b>15</b>
Getting Started .....	17
Before You Begin .....	17
System Requirements .....	18
Supported Interfaces .....	19
IO Libraries Versions Support .....	20
Installing New IO Libraries .....	21
Steps to Install New IO Libraries (Standard) .....	21
Steps to Install New IO Libraries (Modified) .....	27
What Was Created During Installation? .....	33
Where to go Next .....	35
Upgrading Existing IO Libraries .....	36
Steps to Upgrade the IO Libraries .....	36
What Was Created During Installation? .....	42
Where to go Next .....	44
Maintaining Existing IO Libraries .....	45
Steps to Modify the IO Libraries .....	45
Steps to Repair the IO Libraries .....	48
Steps to Remove the IO Libraries .....	50

<b>3. Using IO Configuration Utilities .....</b>	<b>53</b>
Getting Started .....	55
Before You Begin Configuration .....	55
Getting Started Using IO Configuration Utilities .....	55
Using IO Config .....	56
IO Config Requirements .....	56
Running IO Config .....	57
Example: Using IO Config .....	59
Using VISA Assistant.....	61
VISA Assistant Overview .....	61
Running VISA Assistant .....	61
Using the VXI Resource Manager .....	62
VXI Resource Manager Overview .....	62
Opening VXI Resource Manager .....	63
Displaying VXI Resource Manager Output .....	66
Using the LAN Server.....	67
Starting the LAN Server .....	67
Stopping the LAN Server .....	67
<b>4. Configuring I/O Interfaces .....</b>	<b>69</b>
Configuring GPIB Interfaces.....	71
GPIB Interfaces Overview .....	71
Configuring GPIB (82350 PCI) Interfaces .....	72
Configuring GPIB (82341 ISA) Interfaces .....	75
Configuring VXI Interfaces.....	78
VXI Interfaces Overview .....	78
Configuring GPIB-VXI (E1406A) Interfaces .....	79
Configuring VXI (E8491B) Interfaces .....	82
Configuring LAN Interfaces .....	85
LAN Interfaces Overview .....	85
Configuring LAN Client Interfaces .....	90
Configuring VISA LAN Client Interfaces .....	94
Configuring LAN Server Interfaces .....	100
Configuring Other Interfaces .....	103
ASRL and GPIO Interface Overview .....	103
Configuring ASRL Interfaces .....	104
Configuring GPIO Interfaces .....	107
<b>Index .....</b>	<b>111</b>

## Notice

The information contained in this document is subject to change without notice.

Agilent Technologies shall not be liable for any errors contained in this document. *Agilent Technologies makes no warranties of any kind with regard to this document, whether express or implied. Agilent Technologies specifically disclaims the implied warranties of merchantability and fitness for a particular purpose.* Agilent Technologies shall not be liable for any direct, indirect, special, incidental, or consequential damages, whether based on contract, tort, or any other legal theory, in connection with the furnishing of this document or the use of the information in this document.

## Warranty Information

A copy of the specific warranty terms applicable to your Agilent Technologies product and replacement parts can be obtained from Agilent Technologies, Inc.

## U.S. Government Restricted Rights

The Software and Documentation have been developed entirely at private expense. They are delivered and licensed as "commercial computer software" as defined in DFARS 252.227- 7013 (Oct 1988), DFARS 252.211-7015 (May 1991) or DFARS 252.227-7014 (Jun 1995), as a "commercial item" as defined in FAR 2.101(a), or as "Restricted computer software" as defined in FAR 52.227-19 (Jun 1987)(or any equivalent agency regulation or contract clause), whichever is applicable. You have only those rights provided for such Software and Documentation by the applicable FAR or DFARS clause or the Agilent standard software agreement for the product involved.

## **Trademark Information**

Microsoft®, Windows ® 95, Windows ® 98, Windows ® 2000, Windows ® Me and Windows NT® are U.S. registered trademarks of Microsoft Corporation. All other brand and product names are trademarks or registered trademarks of their respective companies.

## **Printing History**

Edition 1 - September 1995

Edition 2 - May 1996

Edition 3 - October 1996

Edition 4 - May 2000

Edition 5 - July 2001

## **Copyright Information**

*Agilent IO Libraries Installation and Configuration Guide for Windows*  
Edition 5

Copyright © 1984, 1985-1988 Sun Microsystems, Inc.

Copyright © 1996 Microsoft Corporation

Copyright © 1995-1996, 2000-2001 Agilent Technologies, Inc.

All rights reserved.

---

## **Introducing the IO Libraries**

---

## Introducing the IO Libraries

This *Agilent IO Libraries Installation Guide for Windows* shows how to install and configure Agilent IO Libraries on Windows 95, Windows 98, Windows Me, Windows NT 4.0, and Windows 2000.

### NOTE

This guide does not include instructions to install IO Libraries on HP-UX systems. See the *I/O Libraries Installation and Configuration Guide for HP-UX* for HP-UX system installation.

Unless otherwise indicated, Windows NT refers to Windows NT 4.0.

This chapter shows how to use this guide and provides an overview of the Agilent IO Libraries.

- *Chapter 2 - Installing the IO Libraries* provides an overview of the Agilent IO Libraries and shows how to install, update, and maintain the libraries on Windows platforms.
- *Chapter 3 - Configuring I/O Interfaces* gives guidelines to use the I/O utilities (IO Config, VISA Assistant, VXI Resource Manager, and LAN Server) to configure GPIB, VXI, LAN, RS-232, and GPIO interfaces.



## Using This Guide

This guide shows how to install and configure the Agilent IO Libraries software.

### What's in This Guide?

The steps described in this guide assume:

- The software will be installed on a Windows-based PC instrument system. The PC can be an external or an embedded PC.
- You have already installed and configured the interfaces for your system and have installed any required application programs (C/C++, Agilent VEE, etc.).
- For an overview of the Agilent IO Libraries, see *Chapter 1 - Introducing the IO Libraries*. To install the Agilent IO Libraries, see *Chapter 2 - Installing the IO Libraries*. To use IO utilities (such as IO Config) to configure the IO Libraries, see *Chapter 3 - Using IO Configuration Utilities*. For details on configuring interfaces, see *Chapter 4 - Configuring I/O Interfaces*.

### If You Need Help

- In the USA and Canada, you can reach Agilent Technologies at these telephone numbers:  
USA: 1-800-452-4844  
Canada: 1-877-894-4414
- Outside the USA and Canada, contact your country's Agilent support organization. A list of contact information for other countries is available on the Agilent web site:

<http://www.agilent.com/find/assist>

---

## IO Libraries Overview

The Agilent IO Libraries application consists of two libraries: *Agilent Virtual Instrument Software Architecture (VISA)* and *Agilent Standard Instrument Control Library (SICL)* plus four I/O Utilities: IO Config, VISA Assistant, VXI Resource Manager, and LAN Server. See *Chapter 3 - Configuring I/O Interfaces* for details on the I/O Utilities.

### NOTE

Since VISA and SICL are different libraries, using VISA functions and SICL functions in the same I/O application is not supported.

## Agilent VISA Description

*Agilent Virtual Instrument Software Architecture (VISA)* is an I/O library that can be used to develop I/O applications and instrument drivers that comply with the *VXIplug&play* standards. Applications and instrument drivers developed with VISA can execute on *VXIplug&play* system frameworks that have the VISA I/O layer. Therefore, software from different vendors can be used together on the same system.

Use VISA if you want to use *VXIplug&play* instrument drivers in your applications, or if you want the I/O applications or instrument drivers that you develop to be compliant with *VXIplug&play* standards. If you are using new instruments or are developing new I/O applications or instrument drivers, we recommend you use Agilent VISA.

### VISA Support

The 32-bit version of VISA is supported on this version of the Agilent IO Libraries for Windows 95, Windows 98, Windows Me, Windows NT, and Windows 2000. Support for the 16-bit version of VISA was removed in version H.01.00. However, versions through G.02.02 support 16-bit VISA. C, C++, and Visual Basic are supported on all these Windows versions.

### VISA Users

VISA has two specific types of users. The first type is the instrumentation end user who wants to use *VXIplug&play* instrument drivers in his or her applications. The second type of user is the instrument driver or I/O application developer who wants to be compliant with *VXIplug&play* standards.

Software development using VISA is intended for instrument I/O and C/C++ or Visual BASIC programmers who are familiar with Windows 95, Windows 98, Windows Me, Windows 2000, or Windows NT. To perform VISA installation and configuration on Windows NT, you must have system administration privileges on the Windows NT system.

VISA  
 Documentation

This table shows associated documentation you can use when programming with Agilent VISA.

**Agilent VISA Documentation**

Document	Description
<i>Agilent VISA User's Guide</i>	Shows how to use Agilent VISA and provides the VISA language reference.
<i>VISA Online Help</i>	Information is provided in the form of Windows Help.
<i>VISA Example Programs</i>	Example programs are provided online to help you develop VISA applications.
<i>VXIplug&amp;play System Alliance VISA Library Specification 4.3</i>	Specifications for VISA.
<i>IEEE Standard Codes, Formats, Protocols, and Common Commands</i>	ANSI/IEEE Standard 488.2-1992.
VXIbus Consortium specifications (when using VISA over LAN)	<i>TCP/IP Instrument Protocol Specification - VXI-11, Rev. 1.0</i> <i>TCP/IP-VXIbus Interface Specification - VXI-11.1, Rev. 1.0</i> <i>TCP/IP-IEEE 488.1 Interface Specification - VXI-11.2, Rev. 1.0</i> <i>TCP/IP-IEEE 488.2 Instrument Interface Specification - VXI-11.3, Rev. 1.0</i>

## Agilent SICL Description

*Agilent Standard Instrument Control Library* (SICL) is an I/O library developed by Agilent that is portable across many I/O interfaces and systems. I/O applications using this library can be ported at the source code level from one system to another with few (or no) changes. You can use Agilent SICL if you have been using SICL and want to remain compatible with software currently implemented in SICL.

**SICL Support**                      The 32-bit version of SICL is supported on this version of the Agilent IO Libraries for Windows 95, Windows 98, Windows Me, Windows NT, and Windows 2000. Support for the 16-bit version of SICL was removed in version H.01.00. However, versions through G.02.02 support 16-bit SICL. C, C++, and Visual BASIC are supported on all these Windows versions.

**SICL Users**                      SICL is intended for instrument I/O and C/C++ or Visual Basic programmers who are familiar with Windows 95, Windows 98, Windows Me, Windows 2000, or Windows NT. To perform SICL installation and configuration on Windows NT, you must have system administration privileges on the Windows NT system.

**SICL Documentation**              This table shows associated documentation you can use when programming with Agilent SICL.

### Agilent SICL Documentation

Document	Description
<i>Agilent SICL User's Guide for Windows</i>	Shows how to use Agilent SICL and provides the SICL language reference.
<i>SICL Online Help</i>	Information is provided in the form of Windows Help.
<i>SICL Example Programs</i>	Example programs are provided online to help you develop SICL applications.
VXIbus Consortium specifications (when using VISA over LAN)	<i>TCP/IP Instrument Protocol Specification - VXI-11, Rev. 1.0</i> <i>TCP/IP-VXIbus Interface Specification - VXI-11.1, Rev. 1.0</i> <i>TCP/IP-IEEE 488.1 Interface Specification - VXI-11.2, Rev. 1.0</i> <i>TCP/IP-IEEE 488.2 Instrument Interface Specification - VXI-11.3, Rev. 1.0</i>

## **IO Config Description**

The IO Config utility is used by the Agilent IO Libraries to configure instrument I/O hardware interfaces. An interface must be configured with IO Config before the interface can be used with the IO Libraries. You can configure all available interfaces with IO Config for use with the Agilent IO Libraries. With IO Config, you can also add, edit, or remove configuration entries for the interface(s) you specify.

IO Config is an interactive program that searches your system for installed interfaces that VISA and SICL support. You select the interface(s) you want to configure and IO Config selects default parameters required to configure the interface(s).

You can run IO Config at any time. However, you must first install an interface card in your system before you can configure the interface. IO Config will verify that an interface card is installed before a configuration entry will be added for the card.

You must have system administrator privileges on Windows 2000/NT to run IO Config. You may also need to reboot the computer if you add or modify interfaces with IO Config to load or update driver files for specific interfaces in the Windows kernel. IO Config will inform you if it is necessary to reboot your computer.

## **VISA Assistant Description**

VISA Assistant is an application program that uses the IO Libraries to communicate with and to control VXI, GPIB, and serial Instruments.

VISA Assistant can automatically detect and assign *VXIplug&play* instrument drivers to instruments. VISA Assistant can also be used to send and receive strings to instruments which support formatted I/O. For other instruments, VISA Assistant allows you to read and write memory areas. VISA Assistant also describes attributes that are associated with an instrument.

## **VXI Resource Manager Description**

If your system includes an E8491 IEEE-1394 PC Link to VXI interface, you can view the output of the VXI Resource Manager to determine if your system is properly configured. The easiest way to view this output is to use the IO Config utility to run the VXI Resource Manager.

The VXI Resource Manager initializes and prepares the VXI system for use. The VXI Resource Manager will run when:

- VXI mainframe power is applied or cycled
- The E8491 **Reset** button is pressed
- It is activated from the IO Config utility
- It is activated from the Agilent IO Libraries Control icon
- The computer is rebooted

In VXI systems with multiple E8491s, individual mainframes can be turned off without affecting other mainframes in the system. When a mainframe is turned on, the VXI Resource Manager reconfigures the mainframe.

## **LAN Server Description**

If you configured the LAN server on your system using IO Config, you must now start the LAN server process on the system. To start the LAN server, you can *either* restart (reboot) your system now or manually start the LAN server process on your system.

---

## **Installing the IO Libraries**

---

## Installing the IO Libraries

This chapter shows how to install the libraries on Windows 95, Windows 98, Windows Me, Windows NT, and Windows 2000. Chapter contents are:

- Getting Started
- Installing New IO Libraries
- Upgrading Existing IO Libraries
- Maintaining Existing IO Libraries

See the following table to select the applicable installation section for your PC configuration. Note that IO Library version numbers skip from H to J. There are no I versions of the Agilent IO Libraries.

Version Installed	Action	See*
None	Install a new version of the IO Libraries	"Installing New IO Libraries"
H.01.03 or earlier	Upgrade existing IO Libraries to the latest version	"Upgrading Existing IO Libraries"
J.01.00 or later	Modify, repair, or remove the same version of existing IO Libraries	"Maintaining Existing IO Libraries"

\* See "Getting Started" first



---

## Getting Started

This section gives guidelines to get started installing the Agilent IO Libraries, including system requirements and supported interfaces. You should verify that your system meets the minimum requirements shown and the system interfaces are supported before you install the Agilent IO Libraries.

### Before You Begin

Before you begin installation of the Agilent IO Libraries, please consider the following items.

#### Create an Emergency Repair Disk

The Agilent IO Libraries include I/O drivers for various PCI plug-in cards. Extensive testing of these drivers and cards has revealed that early revisions of the BIOS code in several PCs are not completely PCI-compliant. This has caused problems when running the Agilent IO Libraries, whether or not the PCI card is installed. Problems can include system errors, operating system crashes, or card initialization failures.

For Windows 2000/NT operating systems, most PC manufacturers recommend that before installing any PCI card, you first create an EMERGENCY REPAIR DISK. If your PC exhibits any abnormal behavior following installation of the Agilent IO Libraries, we recommend a BIOS upgrade to the PC. BIOS upgrades are available from most PC manufacturers' websites.

#### Must Configure with IO Config Utility

Before you can use an interface with SICL or VISA, you **must** first configure the interface with the IO Config utility. See *Chapter 3 - Using IO Configuration Utilities* for details on IO Config. Do **not** attempt to manually edit the Windows registry to configure your interfaces for use with SICL or VISA.

#### See the Readme File

When the Agilent IO Libraries are installed, an Agilent IO Libraries Readme file is created. This file contains very important information that you should read **BEFORE** you configure IO interfaces. To access the Readme file, click the blue IO icon (on the taskbar). Then, click **View Documentation** and then click **IO Libraries Readme**.

**Getting Started****System Requirements**

The following table summarizes **minimum** hardware and software requirements to install and use the IO Libraries. Adding additional RAM may improve overall system performance.

Item	Minimum Requirements
<b>Hardware Requirements</b>	
PC Operation/ Memory	100 MHz operation and 16 MB RAM.
PC Plug-in Slots	EISA I/O slots for GPIB, RS-232, or GPIO interface or for a LAN adapter. PCI slots for GPIB (PCI) and IEEE-1394 interfaces. <sup>1</sup>
Hard Drive Space	At least 40 MB for VISA and SICL installation.
<b>Software Requirements</b>	
Operating System	Windows 95, Windows 98, Windows Me, Windows 2000, or Windows NT.
Language Tools (one of the listed tools)	<ul style="list-style-type: none"> <li>- Microsoft 32-bit Visual C++ Version 2.0 or later or equivalent Microsoft 32-bit C/C++ tools</li> <li>- Borland C++ Version 4.0 or later</li> <li>- Microsoft 32-bit Visual Basic Version 4.0 or later</li> <li>- Other programming tools, such as Agilent VEE, etc.</li> </ul>

<sup>1</sup> If you use an RS-232 interface with VISA and SICL, see the RS-232 documentation for your Windows product, since VISA and SICL use the RS-232 capabilities built into Windows.

## Supported Interfaces

This table shows the I/O interfaces supported for 32-bit applications (16-bit applications are not supported). The table shows the IO Libraries version (or later) required, based on the IO interface and operating system used. For example, a J.02.00 entry means version J.02.00 or later.

	Windows 95	Windows 98	Windows Me	Windows 2000	Windows NT 4.0
<b>ISA Interfaces</b>					
<b>82335B</b> GPIB Interface for MS Windows and DOS	J.02.00 SICL Only <sup>1</sup>	No	No	No	No
<b>82341C</b> High-Performance GPIB Interface for Windows	J.02.00	J.02.00	No	J.02.00	J.02.00
<b>82341D</b> High-Performance GPIB Interface for Windows	J.02.00	No	No	No	No
<b>E2075A</b> General Purpose IO Interface for Windows	J.02.00 SICL Only	J.02.00 SICL Only	No	J.02.00 SICL Only	J.02.00 SICL Only
<b>PCI Interface</b>					
<b>82350A</b> PCI High-Performance GPIB Interface for Windows	J.02.00	J.02.00	J.02.00	J.02.00	J.02.00
<b>VXI Interfaces</b>					
<b>E1406A</b> VXI GPIB Command Module (C-Size)	J.02.00	J.02.00	J.02.00	J.02.00	J.02.00
<b>E623x</b> VXI Embedded Pentium Controllers	G.02.02 or H.01.02	No	No	No	G.02.02 or H.01.02
<b>E8491</b> IEEE-1394 PC Link to VXI, C-Size	J.02.00	J.02.00	J.02.00	J.02.00	J.02.00
<b>E985x</b> Embedded VXI Controllers	No	No	No	No	H.01.03
<b>Other Interfaces</b>					
<b>E2050</b> LAN/GPIB Gateway	J.02.00	J.02.00	J.02.00	J.02.00	J.02.00
<b>RS-232</b> Serial Interface	J.02.00	J.02.00	J.02.00	J.02.00	J.02.00

<sup>1</sup> Not Recommended

**Getting Started****IO Libraries Versions Support**

This table shows the operating systems and interfaces supported by versions G.02.00 through K.01.00 of the Agilent IO Libraries. See “Supported Interfaces” for a description of each interface.

<b>IO Libraries Version</b>	<b>Supported Operating Systems</b>	<b>Supported Interfaces</b>		<b>See Note</b>
K.01.00	Windows 98 Windows Me Windows NT 4.0 Windows 2000	82341C 82350A E2050A E1406A	E8491B E623x E985x RS-232	1
J.02.00	Windows 95 Windows 98 Windows Me Windows NT 4.0 Windows 2000	82341C 82341D 82350A E2050A/B	E2075A E1406A E8491B RS-232	2
H.01.02 or H.01.03	Windows 95 Windows 98 Windows NT 4.0	82341C 82341D 82350A E2050A/B E2075A	E1406A E623x E985x E8491A/B	3
G.02.02	Windows 95 Windows 98 Windows NT 4.0 Windows 3.51	82341C 82341D 82350A	E0250A/B E2075A E1406A	4

<sup>1</sup> 82341D and E2075A are not supported on version K.01.00. Use previous versions of IO Libraries. The E2075A is supported on SICL only for Windows 95/98/Me/2000/NT 4.0.

<sup>2</sup> ISA interfaces are not supported on Windows Me. The 82341D is supported on Windows 95 only. The E2075A is supported on SICL only for Windows 95/98/2000/NT 4.0.

<sup>3</sup> H.01.03 ships with the E985x controllers. These versions do not support Windows 3.1 and 3.51 or 16-bit applications on Windows 95/98/Me. The 82341D is supported on Windows 95 only. The E2075A is supported on SICL only for Windows 95/98/Me/2000/NT 4.0.

<sup>4</sup> The 82341D is supported on Windows 95 only. The E2075A is supported on SICL only for Windows 95/98/Me/2000/NT 4.0.

---

## Installing New IO Libraries

Use these steps to install a **new** version of the IO Libraries on your PC. The steps in this section assume **no** version of the IO Libraries is installed on the PC.

- If you have a version of the IO Libraries already installed on your PC and want to **upgrade**, see “Upgrading Existing IO Libraries”.
- If you want to modify, repair, or remove **the same version** of an existing IO Library, see “Maintaining Existing IO Libraries”.

### Steps to Install New IO Libraries (Standard)

This section shows how to install new IO Libraries for a standard installation. For the systems listed in the following NOTE, skip this section and go to “Steps to Install New IO Libraries (Modified)”.

#### NOTE

This section does **NOT** apply to a Windows 95/98/Me/2000 operating system and a 1394 PCI FireWire card connected to an Agilent E8491B VXI interface or to a Windows 95/98/Me/2000 operating system and an Agilent 82350 PCI GPIB card.

For these systems, **SKIP** this section and go to “Steps to Install New IO Libraries (Modified)”. For other interfaces, or for Windows NT 4.0, use this section and **SKIP** “Steps to Install New IO Libraries (Modified)”.

- 1 Turn the PC OFF and install all IO interface cards required for your application. See the applicable hardware installation guide for installation steps.
- 2 Turn the PC ON and close all open applications. As required, install application software such as C/C++, VEE, etc. on your PC.
- 3 Insert the *Agilent IO Libraries for Instrument Control* CD into the CD-ROM drive and wait a few seconds for the application to run. The installer should automatically start when the CD is inserted. If not, select `Start|Run` and type `<drive>:setup.exe` where *drive* is your CD-ROM drive letter.

## Installing New IO Libraries

- 4 The InstallShield® Wizard appears to begin the IO Libraries installation.

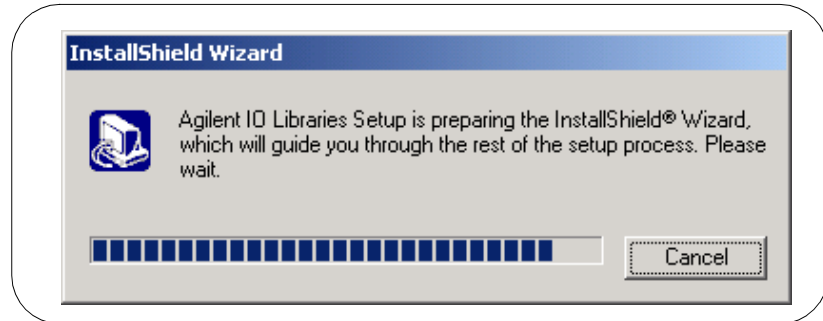

- 5 When the title screen appears, click **N**ext > to go to the **License Agreement** screen and then click **Y**es to accept the license terms and to display the **Readme Information** screen.

### NOTE

The **Readme Information** screen contains important information on the IO Libraries. We suggest you read this information before continuing with IO Libraries installation.

- 6 Click **N**ext > to display the **SICL installation directory** screen. By default, SICL is installed in C:\Program Files\Agilent\IO Libraries. Click **N**ext > if you accept the default setting, or set the directory you want and then click **N**ext > to display the **VISA installation directory** screen.
- 7 By default, VISA is installed in C:\Program Files\VISA. Click **N**ext > if you accept the default setting, or set the directory you want and then click **N**ext > to display the **Select Type of Installation** screen

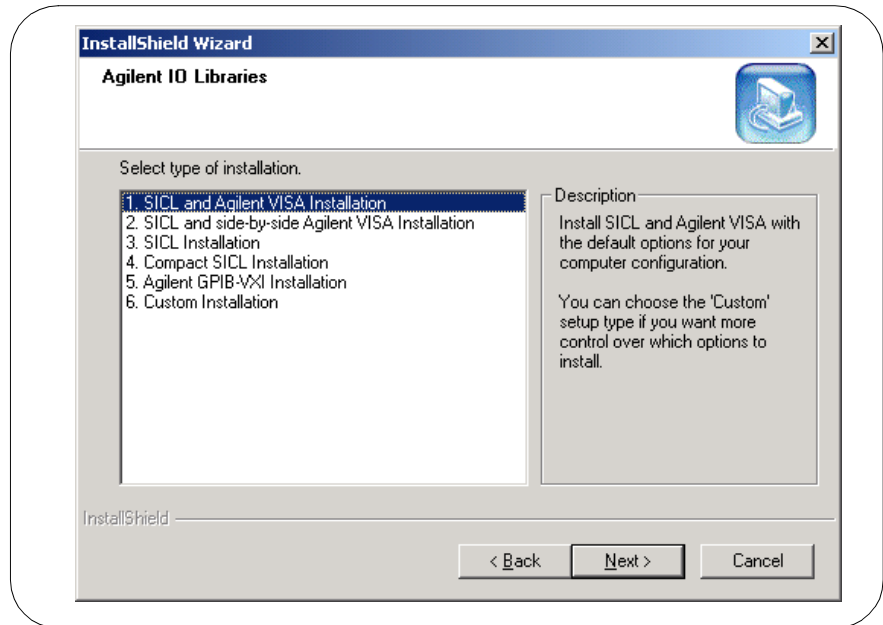

8 Use this table for guidelines to select the type of installation for your application. Then, click **Next >** to install the option.

Option	Description
<b>1. SICL and Agilent VISA Installation</b>	<p>Installs SICL and Agilent VISA with the default options for your computer configuration. This option allows development and runtime capabilities using SICL and Agilent VISA.</p> <p>The option also allows you to select Agilent E8491 IEEE-1394 to VXI support. If another vendor's VISA is installed, installing this option will overwrite the other vendor's VISA.</p>

Installing the IO Libraries  
**Installing New IO Libraries**

Option	Description
<p><b>2. SICL and side-by-side Agilent VISA Installation</b></p>	<p>Installs SICL and side-by-side Agilent VISA with the default options for your computer configuration. With this option, another vendor's VISA <b>will not</b> be overwritten.</p> <p>Beginning with version K.01.00, you can install Agilent VISA as a secondary VISA (side-by-side). When this is done, Agilent VISA <b>will not overwrite</b> another vendor's VISA, if one is present on the computer.</p> <p>Normal VISA programs use <i>visa32.dll</i> which is installed in the Windows system directory. Agilent VISA is implemented in <i>agvisa32.dll</i> which is also installed in the Windows system directory.</p> <ul style="list-style-type: none"> <li>■ If Agilent VISA is installed as the primary VISA, the Agilent version of <i>visa32.dll</i> is installed in the Windows system directory and forwards all VISA calls to <i>agvisa32.dll</i>.</li> <li>■ If Agilent VISA is installed as a secondary VISA, <i>agvisa32.dll</i> is installed but Agilent's <i>visa32.dll</i> is not installed. Thus, Agilent VISA will not overwrite another vendor's <i>visa32.dll</i> which may already be installed.</li> <li>■ If Agilent VISA is installed as a secondary VISA, the support files in the 'bin', 'include' and 'lib' directories of the &lt;VISA Path&gt; (e.g., C:\program files\visa\winnt on Window NT/2000 or C:\program files\visa\win95 on Windows 95/98/Me) are not installed since they would overwrite another vendor's support files.</li> </ul> <p>Copies of the Agilent version of the VISA support files are in the 'agbin', 'include' and 'lib' subdirectories under &lt;VISA Path&gt;\agvisa. These files are installed even when Agilent VISA is the primary VISA.</p> <p>The Agilent VISA utilities <i>vifind32.exe</i> and <i>VISA Assistant</i> use Agilent VISA even if another vendor's VISA is installed as primary VISA.</p> <p>Normally, a VISA program will use the primary VISA (i.e., call through <i>visa32.dll</i>). However, if a VISA program is linked with <i>agvisa32.lib</i> or dynamically loads <i>agvisa32.dll</i>, the program will use Agilent VISA even if it is not the primary VISA.</p>



Option	Description
<b>3. SICL Installation</b>	<p>Installs SICL (but not Agilent VISA) with the default options for your computer configuration. This option allows development and runtime capabilities using SICL.</p> <p>The option also allows you to select Agilent E8491 IEEE-1394 to VXI support. If another vendor's VISA is installed, installing this option <b>will not overwrite</b> the other vendor's VISA.</p>
<b>4. Compact SICL Installation</b>	<p>Installs SICL (but not Agilent VISA) with the default options for your computer configuration. This option allows runtime capabilities ONLY (no development capabilities) using SICL for Serial (RS-232) and LAN client interfaces. If another vendor's VISA is installed, installing this option <b>will not overwrite</b> the other vendor's VISA.</p>
<b>5. Agilent GPIB-VXI Installation</b>	<p>Use this option if your system includes an Agilent VXI Command Module (such as an E1406, etc.) and another vendor's VISA. This option provides GPIB-VXI support for VXI Command Modules on another vendor's VISA. SICL and Agilent VISA are <b>not</b> installed.</p>
<b>6. Custom Installation</b>	<p>Allows you to install individually selected components of the IO Libraries, including SICL, VISA, E8491, I-SCPI, and GPIB-VXI Support components. I-SCPI is supplied for backward compatibility but is <b>not</b> recommended for new applications.</p>

- 9 For the SICL and Agilent VISA Installation (Options 1 and 2) and the SICL Installation (Option 3) ONLY, the **Question** screen for E8491 support appears on Windows 95 and Windows NT. (This support is installed by default on Windows 98, Windows Me, and Windows 2000.) Click **yes** to install Agilent E8491 IEEE-1394 to VXI support, click **No** to not install it.
- 10 Move through the screens (as applicable to the option selected) until you get to the **IO Libraries Configuration** screen. Then, select the type of configuration you want performed (automatic, manual, or none) and click **Next >** to start the installation.
- 11 When installation is complete, the **Installation Complete** screen appears. Note that you must re-start your computer to initialize the IO Libraries. Select the **yes** or **No** option, remove any disks from their drives, and then click **Finish** to complete the installation.

## Installing the IO Libraries

### Installing New IO Libraries

#### NOTE

A different screen will appear if it is not necessary to restart the computer. Even if you are not prompted to restart the computer, if you experience difficulty after installing the IO Libraries, restart the computer to see if this solves the problem.

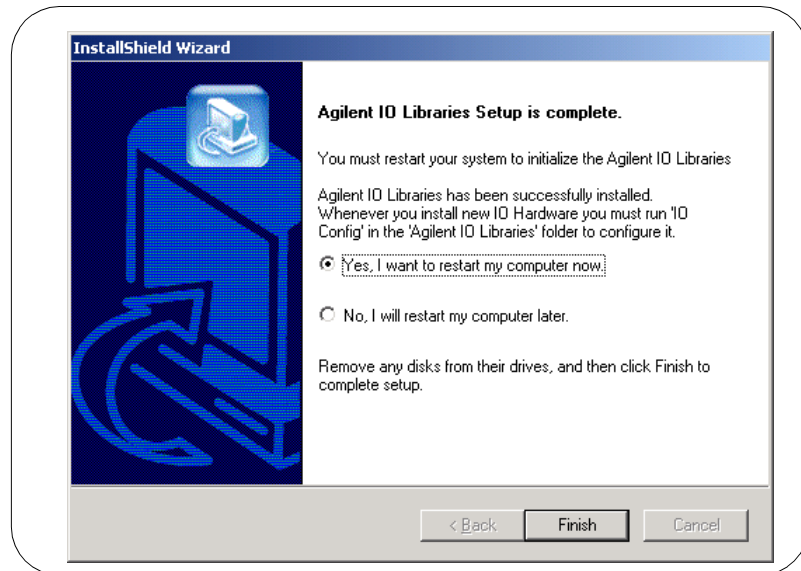

## Steps to Install New IO Libraries (Modified)

### NOTE

This section applies **ONLY** to the systems listed. For a Windows NT 4.0 operating system OR for other IO cards, do **NOT** use this section. Use “Steps to Install New IO Libraries (Standard)”.

- Windows 95/98/Me/2000 operating system and a 1394 PCI FireWire card connected to an Agilent E8491B VXI interface  
or
- Windows 95/98/Me/2000 operating system and an Agilent 82350 PCI GPIB card.

- 1 Turn the PC ON and close all open applications. As required, install application software such as C/C++, VEE, etc. on your PC.
- 2 Insert the *Agilent IO Libraries for Instrument Control* CD into the CD-ROM drive and wait a few seconds for the application to run. The installer should automatically start when the CD is inserted. If not, select **Start | Run** and type `<drive>:setup.exe` where *drive* is your CD-ROM drive letter.
- 3 The InstallShield® Wizard appears to begin the IO Libraries installation.

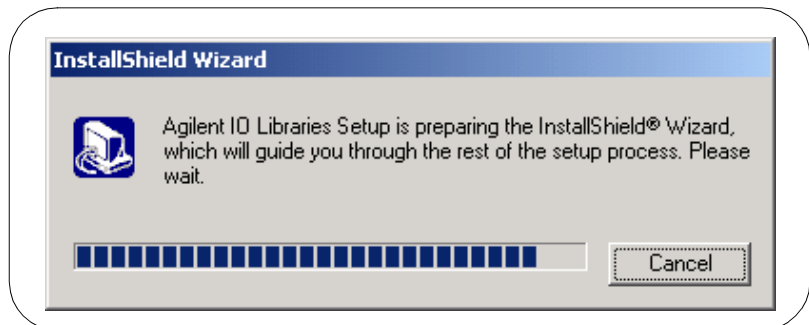

## Installing the IO Libraries

### Installing New IO Libraries

- 4 When the title screen appears, click **N**ext > to go to the **License Agreement** screen and then click **Y**es to accept the license terms and to display the **Readme Information** screen.

#### NOTE

The **Readme Information** screen contains important information on the IO Libraries. We suggest you read this information before continuing with IO Libraries installation.

- 5 Click **N**ext > to display the **SICL installation directory** screen. By default, SICL is installed in C:\Program Files\Agilent\IO Libraries. Click **N**ext > if you accept the default setting, or set the directory you want and then click **N**ext > to display the **VISA installation directory** screen.
- 6 By default, VISA is installed in C:\Program Files\VISA. Click **N**ext > if you accept the default setting, or set the directory you want and then click **N**ext > to display the **Select Type of Installation** screen.

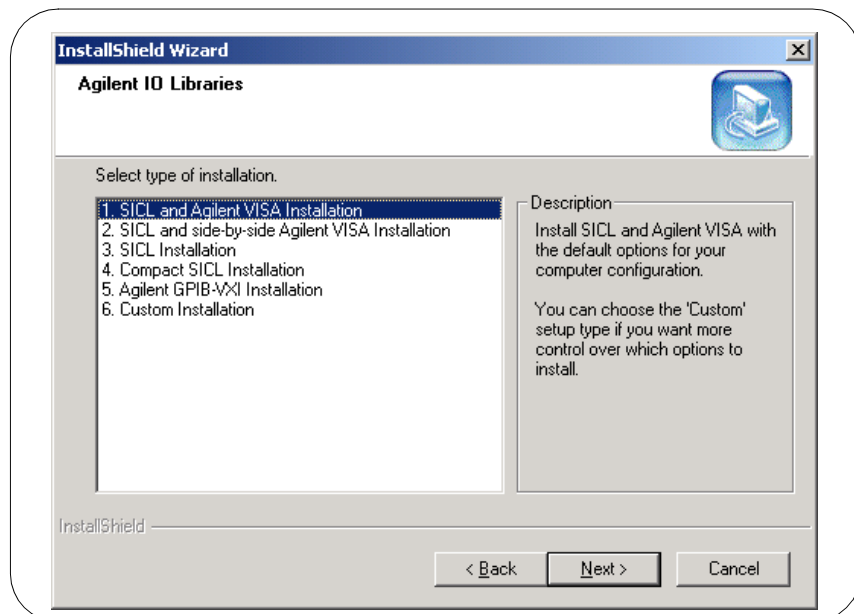

7 Use this table for guidelines to select the type of installation for your application. Then, click **Next** > to install the option.

Option	Description
<p><b>1. SICL and Agilent VISA Installation</b></p>	<p>Installs SICL and Agilent VISA with the default options for your computer configuration. This option allows development and runtime capabilities using SICL and Agilent VISA.</p> <p>The option also allows you to select Agilent E8491 IEEE-1394 to VXI support. If another vendor's VISA is installed, installing this option will overwrite the other vendor's VISA.</p>
<p><b>2. SICL and side-by-side Agilent VISA Installation</b></p>	<p>Installs SICL and side-by-side Agilent VISA with the default options for your computer configuration. With this option, another vendor's VISA <b>will not</b> be overwritten.</p> <p>Beginning with version K.01.00, you can install Agilent VISA as a secondary VISA (side-by-side). When this is done, Agilent VISA <b>will not overwrite</b> another vendor's VISA, if one is present on the computer.</p> <p>Normal VISA programs use <i>visa32.dll</i> which is installed in the Windows system directory. Agilent VISA is implemented in <i>agvisa32.dll</i> which is also installed in the Windows system directory.</p> <ul style="list-style-type: none"> <li>■ If Agilent VISA is installed as the primary VISA, the Agilent version of <i>visa32.dll</i> is installed in the Windows system directory and forwards all VISA calls to <i>agvisa32.dll</i>.</li> <li>■ If Agilent VISA is installed as a secondary VISA, <i>agvisa32.dll</i> is installed but Agilent's <i>visa32.dll</i> is not installed. Thus, Agilent VISA will not overwrite another vendor's <i>visa32.dll</i> which may already be installed.</li> <li>■ If Agilent VISA is installed as a secondary VISA, the support files in the 'bin', 'include' and 'lib' directories of the &lt;VISA Path&gt; (e.g., C:\program files\visa\winnt on Window NT/2000 or C:\program files\visa\win95 on Windows 95/98/Me) are not installed since they would overwrite another vendor's support files.</li> </ul>

Installing the IO Libraries  
**Installing New IO Libraries**

Option	Description
<b>2. SICL and side-by-side Agilent VISA Installation (continued)</b>	<p>Copies of the Agilent version of the VISA support files are in the 'agbin', 'include' and 'lib' subdirectories under &lt;VISA Path&gt;\agvisa. These files are installed even when Agilent VISA is the primary VISA.</p> <p>The Agilent VISA utilities <i>vifind32.exe</i> and <i>VISA Assistant</i> use Agilent VISA even if another vendor's VISA is installed as primary VISA.</p> <p>Normally, a VISA program will use the primary VISA (i.e., call through <i>visa32.dll</i>). However, if a VISA program is linked with <i>agvisa32.lib</i> or dynamically loads <i>agvisa32.dll</i>, the program will use Agilent VISA even if it is not the primary VISA.</p>
<b>3. SICL Installation</b>	<p>Installs SICL (but not Agilent VISA) with the default options for your computer configuration. This option allows development and runtime capabilities using SICL.</p> <p>The option also allows you to select Agilent E8491 IEEE-1394 to VXI support. If another vendor's VISA is installed, installing this option <b>will not overwrite</b> the other vendor's VISA.</p>
<b>4. Compact SICL Installation</b>	<p>Installs SICL (but not Agilent VISA) with the default options for your computer configuration. This option allows runtime capabilities ONLY (no development capabilities) using SICL for Serial (RS-232) and LAN client interfaces. If another vendor's VISA is installed, installing this option <b>will not overwrite</b> the other vendor's VISA.</p>
<b>5. Agilent GPIB-VXI Installation</b>	<p>Use this option if your system includes an Agilent VXI Command Module (such as an E1406, etc.) and another vendor's VISA. This option provides GPIB-VXI support for VXI Command Modules on another vendor's VISA. SICL and Agilent VISA are <b>not</b> installed.</p>
<b>6. Custom Installation</b>	<p>Allows you to install individually selected components of the IO Libraries, including SICL, including SICL, VISA, E8491, I-SCPI, and GPIB-VXI Support components. I-SCPI is supplied for backward compatibility but is <b>not</b> recommended for new applications.</p>

- 8 For the SICL and Agilent VISA Installation (Options 1 and 2) and the SICL Installation (Option 3) ONLY, the **Question** screen for E8491 support appears on Windows 95 and Windows NT. (This support is installed by default on Windows 98, Windows Me, and Windows 2000.) Click yes to install Agilent E8491 IEEE-1394 to VXI support, click no to not install it.

- 9 Move through the screens (as applicable to the option selected) until you get to the **IO Libraries Configuration** screen. Then, select the type of configuration you want performed (automatic, manual, or none) and click **Next >** to start the installation.
- 10 When installation is complete, the **Installation Complete** screen appears. Note that you must re-start your computer to initialize the IO Libraries. Select the **Do not configure interfaces now** option, remove any disks from their drives, and click **Finish** to complete the installation.

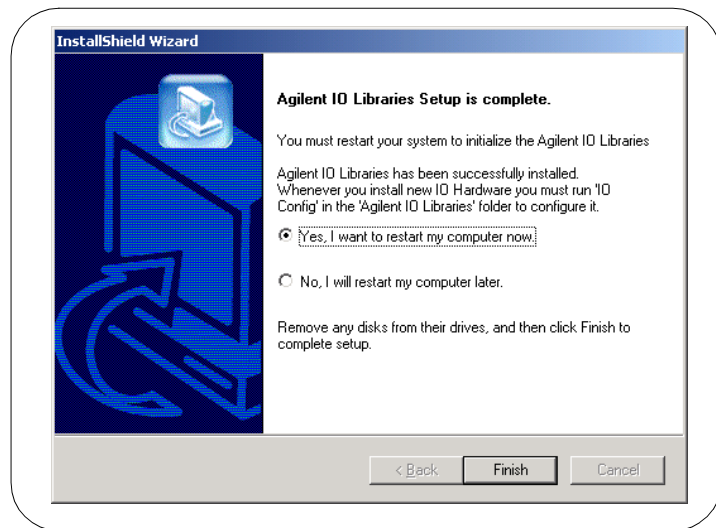

- 11 Shut down the computer and turn power off. Install an IEEE-1394 FireWire card and/or Agilent 82350A PCI GPIB card. Use a FireWire cable to connect the IEEE-1394 card to an E8491B VXI interface card in a VXI mainframe. Power up the mainframe.
- 12 Turn the computer ON. As Windows 95/98/Me/2000 restarts, the **Found New Hardware Wizard** will start. Use this Wizard to complete the installation as shown in Steps 14 and/or 15.

## Installing New IO Libraries

### 13 *1394 FireWire Card connected to an E8491B VXI Interface Card*

- **Windows 95.** If the Wizard asks for the HPI/OLibraries CD, click **OK**. When the Wizard asks for the *wn1394.vxd* file, browse to C:\windows\system\ and click **OK**.
- **Windows 98.** If the Wizard asks for the *1394bus.sys* file, you must provide the CD for the Windows 98 operating system and let the Wizard search for and install the file. When the Wizard asks for the *IO Libraries* CD, provide the CD or continue to where the Wizard asks for the *1394ipt.sys* file. Then, browse to C:\Winnt\system32\drivers\ and click **OK**.
- **Windows Me.** When the Wizard asks for the *IO Libraries* CD, provide the CD or continue to where the Wizard asks for the *1394ipt.sys* file. Then, browse to C:\Winnt\system32\drivers\ and click **OK**.

### 14 *82350 PCI GPIB Card*

- **Windows 95.** When the Wizard asks for the HPI/OLibraries CD, click **OK**. When the Wizard asks for the *ag350i32.vxd* file, browse to C:\windows\system\ and click **OK**.
- **Windows 98/Me.** When the Wizard asks for the HPIOLibraries CD, click **OK**. When the Wizard asks for the *hpioclas.dll* file, browse to C:\windows\system\ and click **OK**.



## What Was Created During Installation?

Depending on the installation option you selected, SICL and/or VISA were installed and several program icons were created. In addition, an Agilent IO Libraries Control was created.

### Program Groups Created

During installation, the Agilent IO Libraries program group was created. To access this group, click **Start | Programs | Agilent IO Libraries** to display the following icons. Three utilities were installed you can use with the IO Libraries: IO Config, VISA Assistant, and VXI Resource Manager. See *Chapter 3 - Using IO Configuration Utilities* for information on using these utilities.

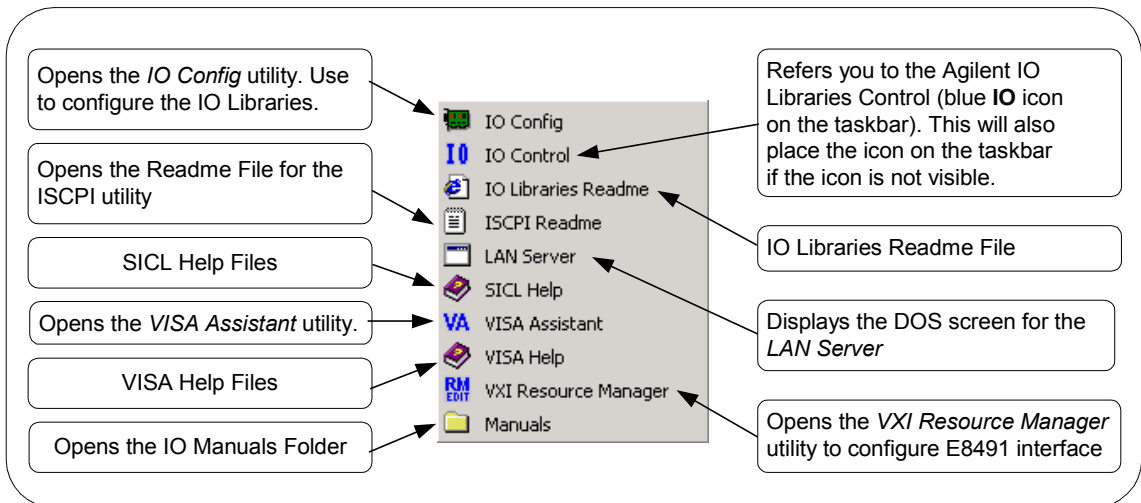

### Agilent IO Libraries Control Icon

In addition to the IO Libraries icons, an Agilent IO Libraries Control icon was created. This icon is located on the Windows taskbar and is shown as a blue **IO** symbol. If the IO Libraries Control icon is not visible, you can display the icon by clicking **Start | Programs | Agilent IO Libraries | IO Control**.

The IO Libraries Control allows you to run VISA Assistant, IO Config, and Message/Event Viewer. It also allows you to select different modes of operation for VISA Logging. See *Chapter 3 - Using IO Configuration Utilities* for details on using IO Config and VISA Assistant.

## Installing the IO Libraries

### Installing New IO Libraries

A typical display follows when **View Documentation** is selected. You can run IO Config, VISA Assistant, or VXI Resource Manager to configure your specific system. In addition, you can run the Event Viewer (Message Viewer) for troubleshooting or you can select VISA Logging for logging messages.

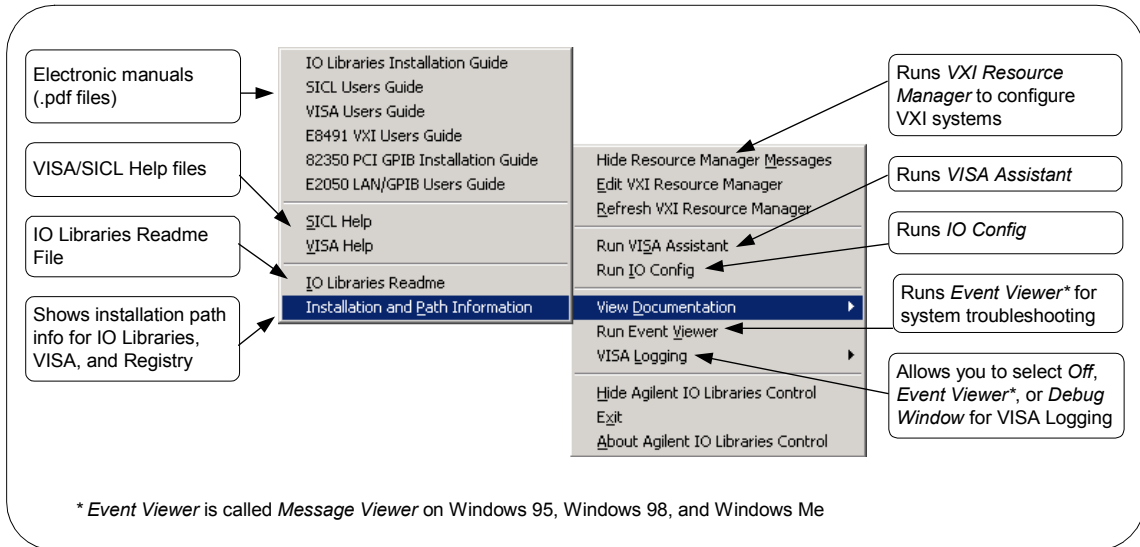

#### NOTE

The **Readme Information** screen contains important information on the IO Libraries. We suggest you read this information before continuing with IO Libraries installation.

Adobe Acrobat Reader is required to view manuals available from the Agilent IO Libraries Control. (Online Help files and the IO Libraries Readme File do not require Acrobat Reader.) If Adobe Acrobat Reader is not present, no error message appears but manuals will not be displayed.

Clicking **View Documentation | Installation and Paths Information** displays the IO Libraries, VISA, and Registry installation paths. This is primarily useful for troubleshooting installation problems. See the following figures for typical displays. The first figure shows Agilent VISA as the primary VISA, while the second figure shows Agilent VISA installed side-by-side with another vendor's VISA.

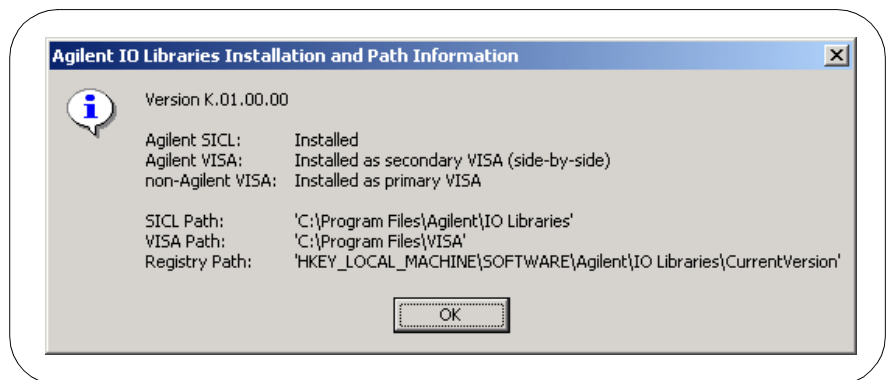
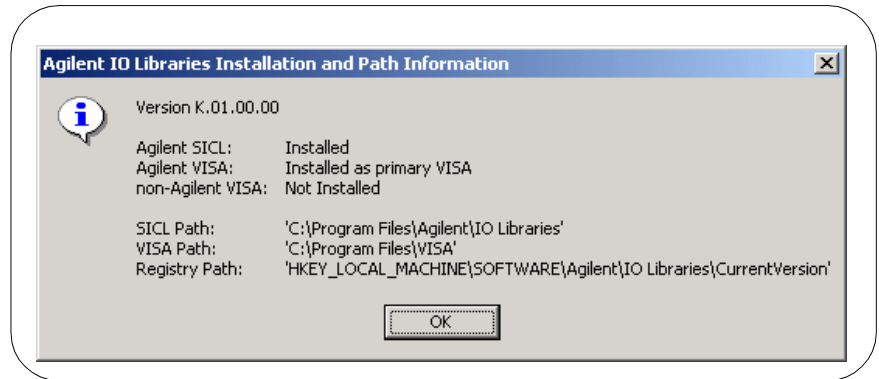

## Where to go Next

You have now completed installation of the Agilent IO Libraries. Go to *Chapter 3 - Using IO Configuration Utilities* for guidelines to configure the Agilent IO Libraries for your PC configuration.

---

## Upgrading Existing IO Libraries

Use these steps to upgrade existing IO Libraries on your PC. The steps in this section assume version H.01.03 or earlier of the IO Libraries is already installed on your PC and you are installing version J.01.00 or later of the IO Libraries.

- If no version of the IO Libraries is installed on your PC and you want to install a **new** version, see “Installing New IO Libraries”.
- If you want to modify, repair, or remove **the same version** of an existing IO Library, see “Maintaining IO Libraries”.

### Steps to Upgrade the IO Libraries

- 1 Turn the PC ON and close all open applications.
- 2 As required, install application software such as C/C++, VEE, etc. on your PC.
- 3 Insert the *Agilent IO Libraries for Instrument Control* CD into the CD-ROM drive and wait a few seconds for the application to run. The installer should automatically start when the CD is inserted. If not, select **Start | Run** and type `<drive>:setup.exe` where *drive* is your CD-ROM drive letter.
- 4 The InstallShield® Wizard appears to begin the IO Libraries installation.

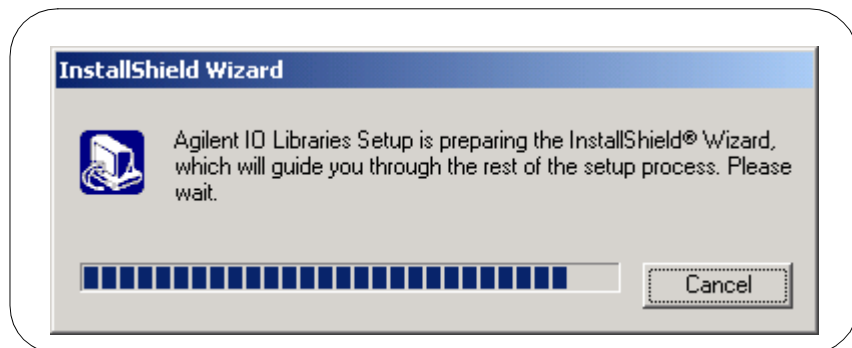

- 5 An **Upgrade** screen appears that shows the current version installed and the new version that will be installed.

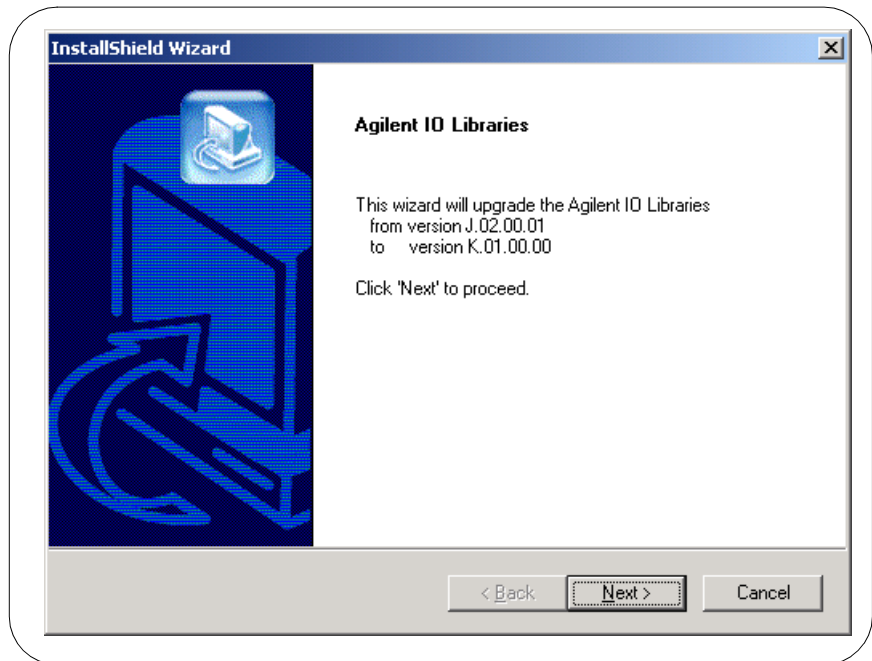

- 6 Click **Next >** to go to the **License Agreement** screen and then click **Yes** to accept the license terms and to display the **Readme Information** screen.

**NOTE**

The **Readme Information** screen contains important information on the IO Libraries. Please read this information before continuing with IO Libraries upgrade.

**NOTE**

If you are installing version J.01.00 or greater of the Agilent IO Libraries, Steps 7 through 9 are skipped.

Installing the IO Libraries  
**Upgrading Existing IO Libraries**

- 7 After reading the ReadMe information, click **Next >** to display the **Select Type of Installation** screen.

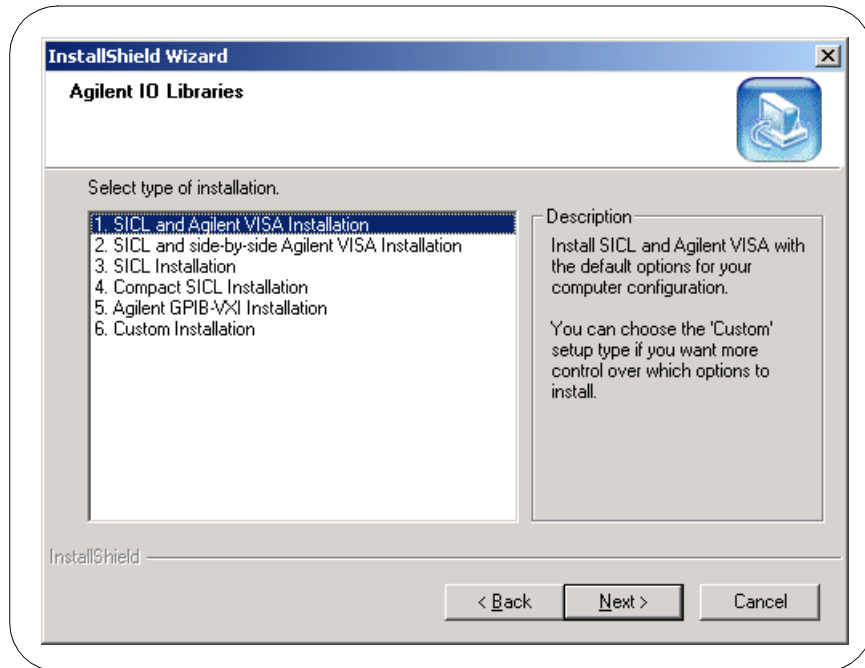

- 8 Use this table for guidelines to select the type of installation for your application. Then, click **Next >** to install the option.

Option	Description
<b>1. SICL and Agilent VISA Installation</b>	Installs SICL and Agilent VISA with the default options for your computer configuration. This option allows development and runtime capabilities using SICL and Agilent VISA. The option also allows you to select Agilent E8491 IEEE-1394 to VXI support. If another vendor's VISA is installed, installing this option will overwrite the other vendor's VISA.

Option	Description
<p><b>2. SICL and side-by-side Agilent VISA Installation</b></p>	<p>Installs SICL and side-by-side Agilent VISA with the default options for your computer configuration. With this option, another vendor's VISA <b>will not</b> be overwritten.</p> <p>Beginning with version K.01.00, you can install Agilent VISA as a secondary VISA (side-by-side). When this is done, Agilent VISA <b>will not</b> overwrite another vendor's VISA, if one is present on the computer.</p> <p>Normal VISA programs use <i>visa32.dll</i> which is installed in the Windows system directory. Agilent VISA is implemented in <i>agvisa32.dll</i> which is also installed in the Windows system directory.</p> <ul style="list-style-type: none"> <li>■ If Agilent VISA is installed as the primary VISA, the Agilent version of <i>visa32.dll</i> is installed in the Windows system directory and forwards all VISA calls to <i>agvisa32.dll</i>.</li> <li>■ If Agilent VISA is installed as a secondary VISA, <i>agvisa32.dll</i> is installed but Agilent's <i>visa32.dll</i> is not installed. Thus, Agilent VISA will not overwrite another vendor's <i>visa32.dll</i> which may already be installed.</li> <li>■ If Agilent VISA is installed as a secondary VISA, the support files in the 'bin', 'include' and 'lib' directories of the &lt;VISA Path&gt; (e.g., C:\program files\visa\winnt on Window NT/2000 or C:\program files\visa\win95 on Windows 95/98/Me) are not installed since they would overwrite another vendor's support files.</li> </ul> <p>Copies of the Agilent version of the VISA support files are in the 'agbin', 'include' and 'lib' subdirectories under &lt;VISA Path&gt;\agvisa. These files are installed even when Agilent VISA is the primary VISA.</p> <p>The Agilent VISA utilities <i>vifind32.exe</i> and <i>VISA Assistant</i> use Agilent VISA even if another vendor's VISA is installed as primary VISA.</p> <p>Normally, a VISA program will use the primary VISA (i.e., call through <i>visa32.dll</i>). However, if a VISA program is linked with <i>agvisa32.lib</i> or dynamically loads <i>agvisa32.dll</i>, the program will use Agilent VISA even if it is not the primary VISA.</p>

Installing the IO Libraries  
**Upgrading Existing IO Libraries**

Option	Description
3. SIDL Installation	Installs SIDL (but not Agilent VISA) with the default options for your computer configuration. This option allows development and runtime capabilities using SIDL. The option also allows you to select Agilent E8491 IEEE-1394 to VXI support. If another vendor's VISA is installed, installing this option <b>will not</b> overwrite the other vendor's VISA.
4. Compact SIDL Installation	Installs SIDL (but not Agilent VISA) with the default options for your computer configuration. This option allows runtime capabilities ONLY (no development capabilities) using SIDL for Serial (RS-232) and LAN client interfaces. If another vendor's VISA is installed, installing this option will not overwrite the other vendor's VISA.
5. Agilent GPIB-VXI Installation	Use this option if your system includes an Agilent VXI Command Module (such as an E1406, etc.) and another vendor's VISA. This option provides GPIB-VXI support for VXI Command Modules on another vendor's VISA. SIDL and Agilent VISA are NOT installed.
6. Custom Installation	Allows you to install individually selected components of the IO Libraries, including SIDL, including SIDL, VISA, E8491, I-SCPI, and GPIB-VXI Support components. I-SCPI is supplied for backward compatibility but is NOT recommended for new applications.

- 9 For the SIDL and Agilent VISA Installation (Options 1 and 2) and the SIDL Installation (Option 3) ONLY, the **Question** screen for E8491 support appears on Windows 95 and Windows NT. (This support is installed by default on Windows 98, Windows Me, and Windows 2000.) Click **Yes** to install Agilent E8491 IEEE-1394 to VXI support, click **No** to not install it.
- 10 Move through the screens (as applicable to the option selected) until you get to the **IO Libraries Configuration** screen. Then, select the type of configuration you want performed (refresh, automatic, manual, or do not configure) and click **Next >** to start the installation.

**NOTE**

The **Refresh Configured Interfaces** option will not search for any unconfigured interfaces. This option will only refresh interfaces that are already configured.



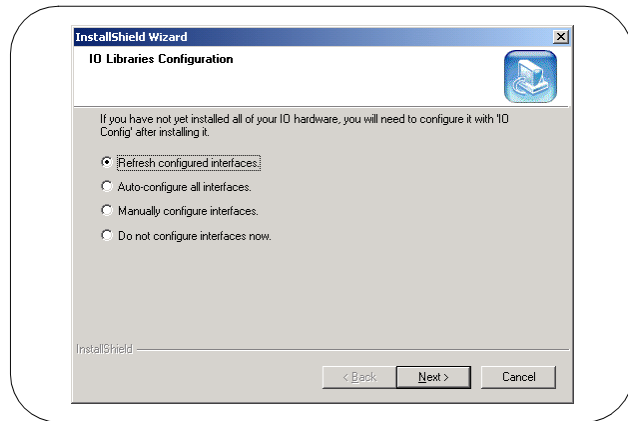

- 11 When installation is complete, the **Installation Complete** screen appears. Note that you must re-start your computer to initialize the IO Libraries. Select the **Yes** or **No** option, remove any disks from their drives, and click **Finish** to complete the installation.

**NOTE**

A different screen will appear if it is not necessary to restart the computer. Even if you are not prompted to restart the computer, if you experience difficulty after installing the IO Libraries, restart the computer to see if this solves the problem.

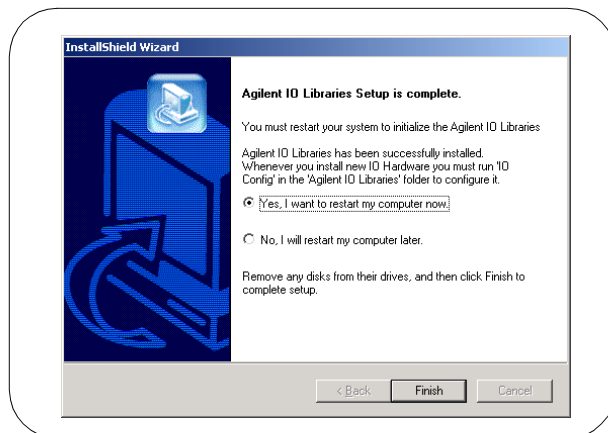

## What Was Created During Installation?

Depending on the installation option you selected, SICL and/or VISA were installed and several program icons were created. In addition, an Agilent IO Libraries Control was created.

### Program Groups Created

During installation, the Agilent IO Libraries program group was created. To access this group, click **Start | Programs | Agilent IO Libraries** to display the following icons. Three utilities were installed you can use with the IO Libraries: IO Config, VISA Assistant, and VXI Resource Manager. See *Chapter 3 - Using IO Configuration Utilities* for information on using these utilities.

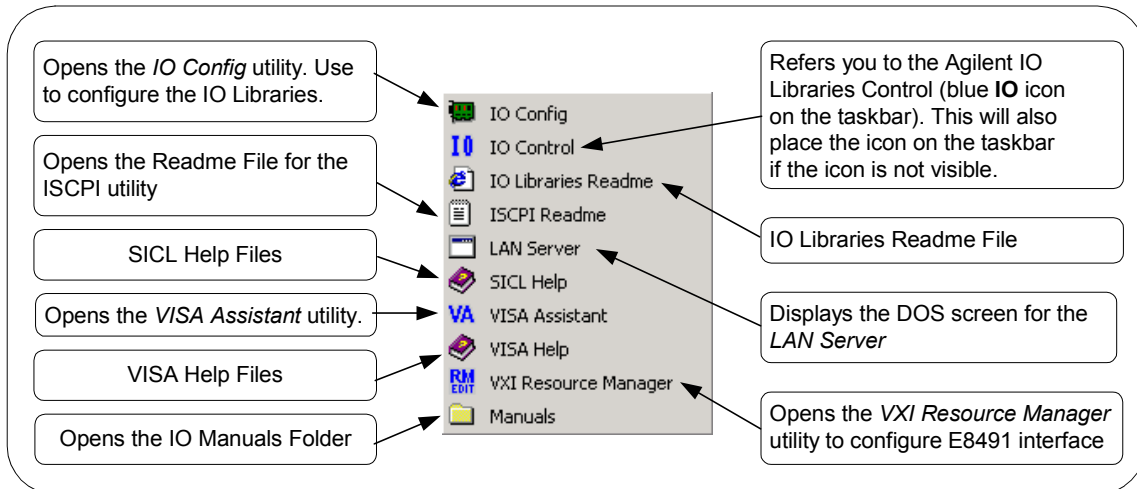

### Agilent IO Libraries Control Icon

In addition to the IO Libraries icons, an Agilent IO Libraries Control icon was created. This icon is located on the right-hand side of the taskbar and is shown as a blue **IO** symbol. If the IO Libraries Control icon is not visible, you can display the icon by clicking **Start | Programs | Agilent IO Libraries | IO Control**.

The IO Libraries Control allows you to run VISA Assistant, IO Config, and Message/Event Viewer. It also allows you to select different modes of operation for VISA Logging. See *Chapter 3 - Using IO Configuration Utilities* for details on using IO Config and VISA Assistant.

A typical display follows, with **View Documentation** highlighted. You can run IO Config, VISA Assistant, or VXI Resource Manager to configure your specific system. In addition, you can run the Event Viewer (Message Viewer) for troubleshooting or you can select VISA Logging for logging messages.

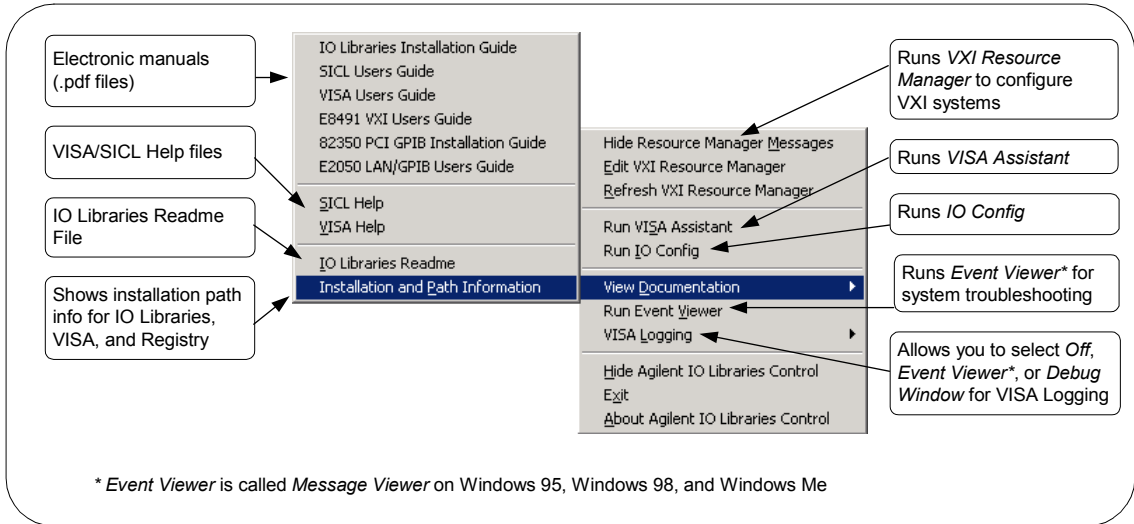

## NOTE

The **Readme Information** screen contains important information on the IO Libraries. We suggest you read this information before continuing with IO Libraries installation.

Adobe Acrobat Reader is required to view manuals available from the Agilent IO Libraries Control. (Online Help files and the IO Libraries Readme File do not require Acrobat Reader.) If Adobe Acrobat Reader is not present, no error message appears but manuals will not be displayed.

## Installing the IO Libraries

### Upgrading Existing IO Libraries

Clicking **View Documentation|Installation and Paths Information** displays the IO Libraries, VISA, and Registry installation paths. This is primarily useful for troubleshooting installation problems. See the following figures for typical displays. The first figure shows Agilent VISA as the primary VISA, while the second figure shows Agilent VISA installed side-by-side with another vendor's VISA.

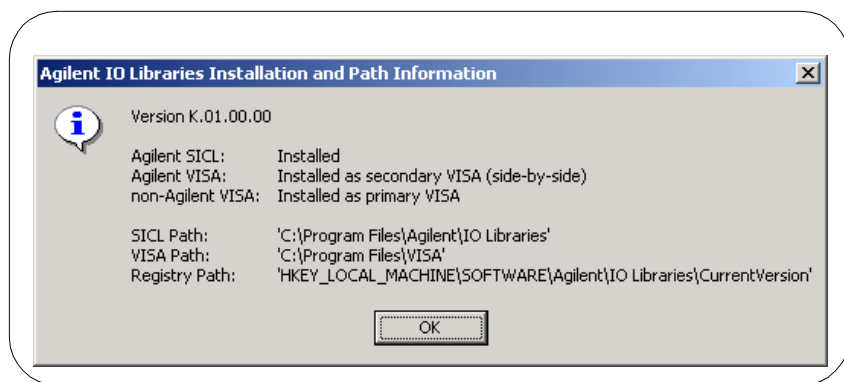
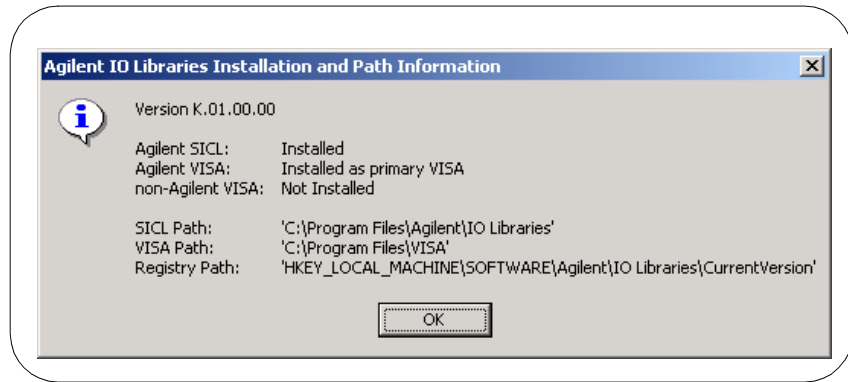

### Where to go Next

You have now completed installation of the Agilent IO Libraries. Go to *Chapter 3 - Using IO Configuration Utilities* for guidelines to configure the Agilent IO Libraries for your PC configuration.

---

## Maintaining Existing IO Libraries

This section gives guidelines to modify, repair, or remove **the same version** of the IO Libraries (version J.01.00 or later) currently installed on your PC.

- To **modify** the same version of an existing IO Library, see “Steps to Modify IO Libraries”.
- To **repair** the same version of an existing IO Library, see “Steps to Repair IO Libraries”.
- To **remove** the same version of an existing IO Library, see “Steps to Remove IO Libraries”.

### Steps to Modify the IO Libraries

- 1 Turn the PC ON and close all open applications.
- 2 Insert the *Agilent IO Libraries for Instrument Control* CD into the CD-ROM drive and wait a few seconds for the application to run. The installer should automatically start when the CD is inserted. If not, select **Start | Run** and type `<drive>:setup.exe` where *drive* is your CD-ROM drive letter.
- 3 The InstallShield® Wizard appears to begin the IO Libraries modification process.

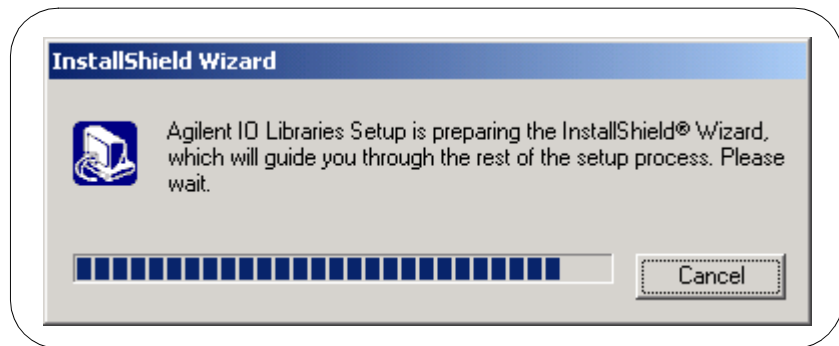

## Installing the IO Libraries

### Maintaining Existing IO Libraries

- 4 After a few seconds, the **Setup Maintenance** screen appears. From this screen, select **M**odify and then click **N**ext > to modify the current IO Libraries installation.

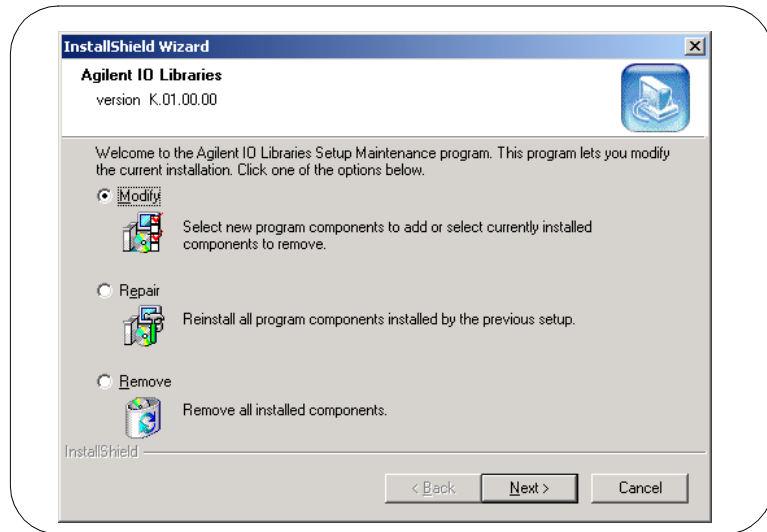

- 5 When the **Tree View** screen appears, select the components you want to install and clear the components you do not want to install. Then, click **N**ext > to begin the (modified) installation.

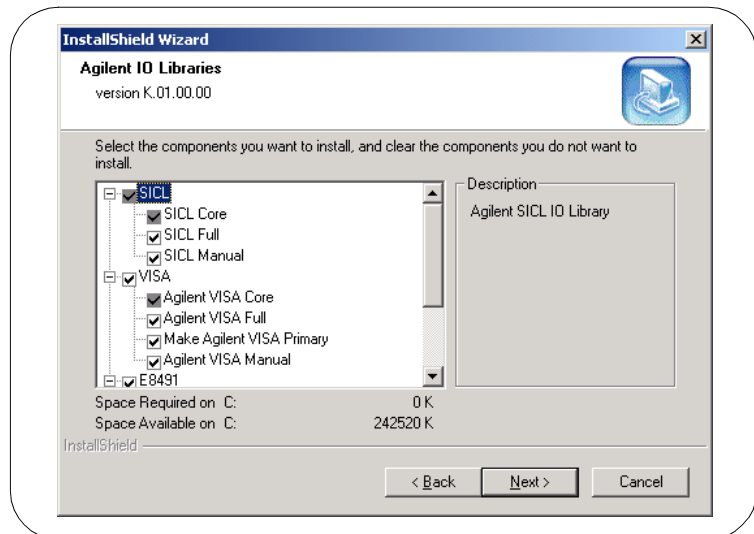

- 6 After the modified setup is installed, the **IO Libraries Configuration** screen appears. Select an option and then click **Next >** to complete the modification process.

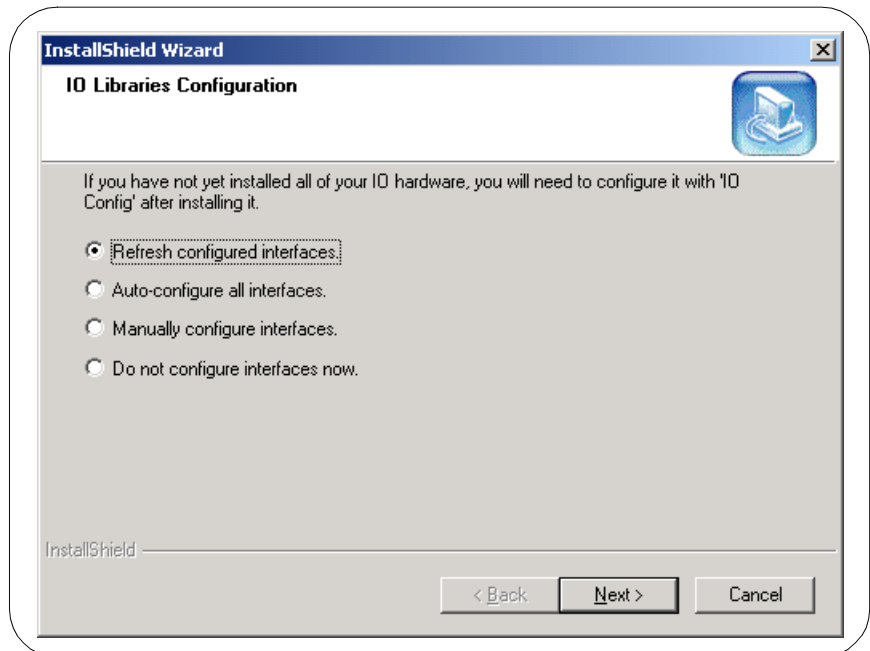

- If you select “Refresh configured interfaces” or “Auto-configure all interfaces”, all applicable interfaces are refreshed or configured.
- If you select “Manually configure interfaces”, the IO Config utility appears from which you can manually configure interfaces. See *Chapter 3 - Using IO Configuration Utilities* for information on IO Config.
- If you select “Do not configure interfaces now”, the **Setup Complete** screen appears that reminds you to run the IO Config utility. See *Chapter 3 - Using IO Configuration Utilities* for information on IO Config.

## Maintaining Existing IO Libraries

- 7 For any option selected, when the **Setup Complete** screen appears, (see the following figure) click **Finish** to complete the process and then remove the *IO Libraries for Instrument Control* CD.

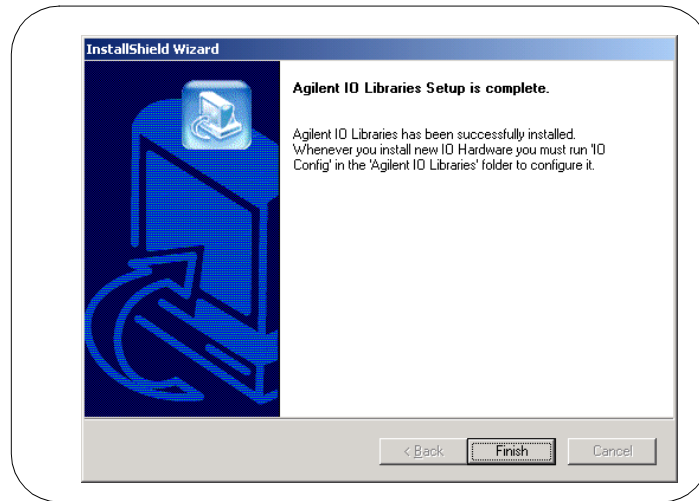

## Steps to Repair the IO Libraries

- 1 Turn the PC ON and close all open applications.
- 2 Insert the *Agilent IO Libraries for Instrument Control* CD into the CD-ROM drive and wait a few seconds for the application to run. The installer should automatically start when the CD is inserted. If not, select **Start | Run** and type `<drive>:setup.exe` where *drive* is your CD-ROM drive letter.
- 3 The InstallShield® Wizard appears to begin the IO Libraries modification process.

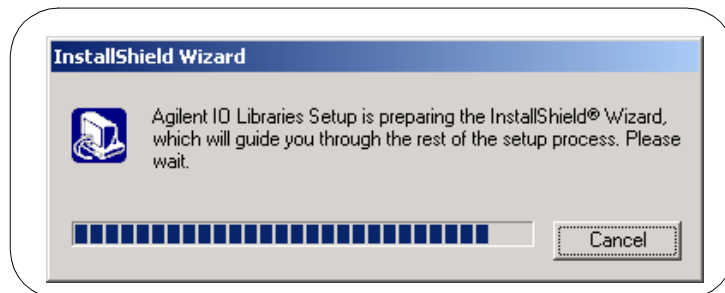



- 4 After a few seconds, the **IO Libraries Setup Maintenance** screen appears. From this screen, select **Repair** and then click **Next >** to re-install the current IO Libraries components.

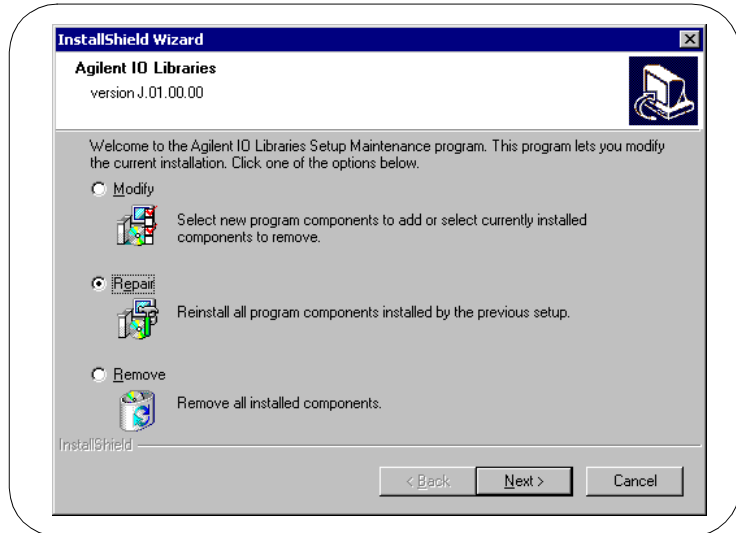

- 5 The **Setup Status** screen appears, and the existing IO Library components are re-installed.

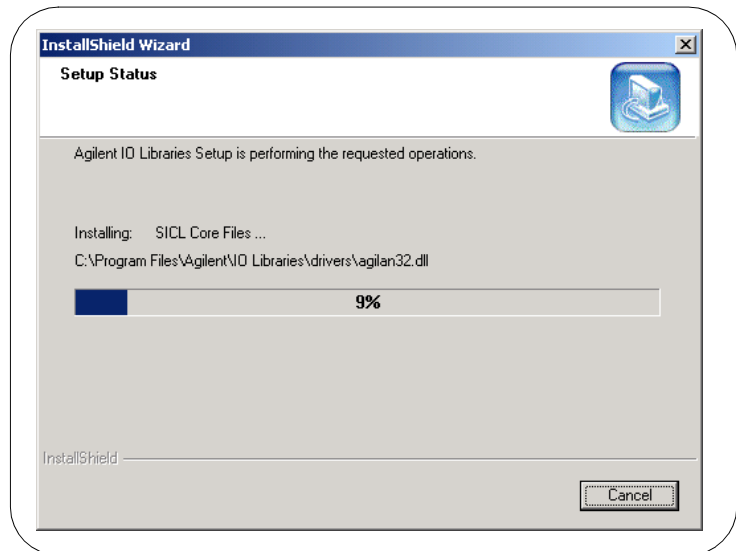

## Maintaining Existing IO Libraries

- 6 When re-installation is complete, the **Setup Complete** screen appears. Click **Finish** to complete the process and then remove the *IO Libraries for Instrument Control* CD.

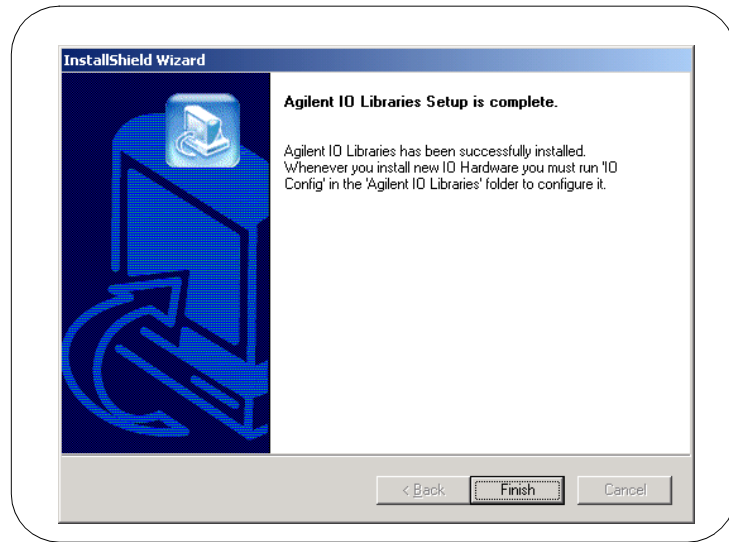

## Steps to Remove the IO Libraries

- 1 Turn the PC ON and close all open applications.
- 2 Insert the *Agilent IO Libraries for Instrument Control* CD into the CD-ROM drive and wait a few seconds for the application to run. The installer should automatically start when the CD is inserted. If not, select **Start | Run** and type `<drive>:setup.exe` where *drive* is your CD-ROM drive letter.
- 3 The InstallShield® Wizard appears to begin the IO Libraries modification process.

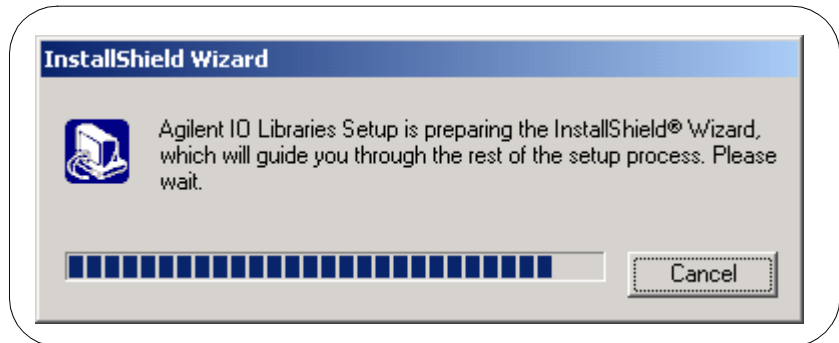

- 4 After a few seconds, the **IO Libraries Setup Maintenance** screen appears. From this screen, select **Remove** and then click **Next** > to remove the current IO Libraries installation.

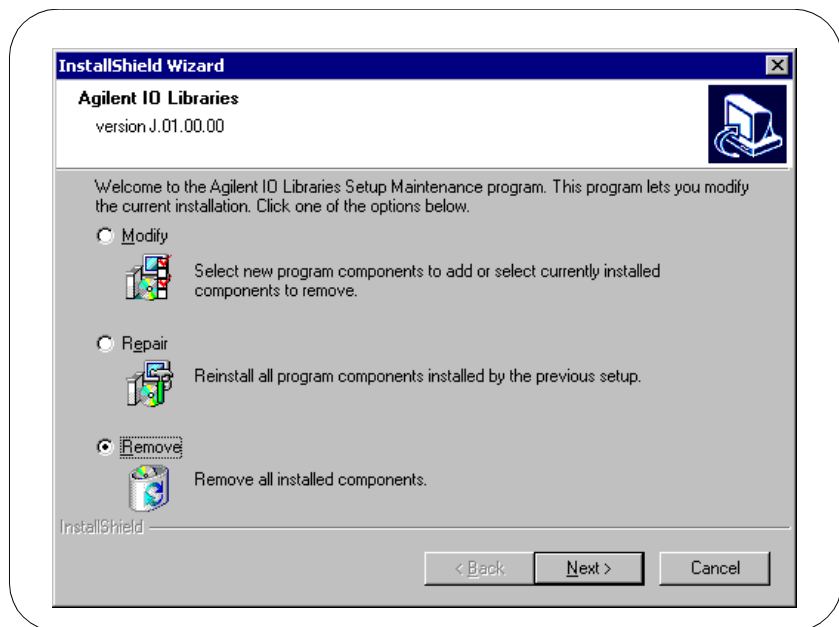

- 5 The **Confirm Delete** screen appears. Click **Yes** to delete all currently installed IO Libraries components.

**Maintaining Existing IO Libraries**

- 6 When component removal is complete, the following screen appears. Click **Finish** to complete the process and then remove the *IO Libraries for Instrument Control CD*.

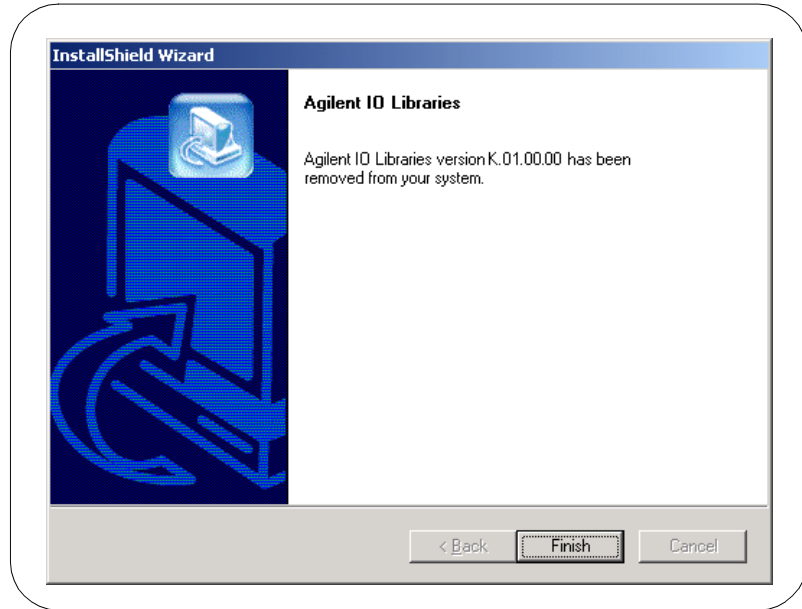

---

## Using IO Configuration Utilities

---

## Using IO Configuration Utilities

This chapter gives guidelines to use IO utilities to configure I/O interfaces, including:

- Getting Started
- Using I/O Config
- Using VISA Assistant
- Using VXI Resource Manager
- Using LAN Server

### NOTE

In most cases, you can open and run the IO Config utility and use the default choices for your specific interface. If you have questions about interface configuration or you want to change the interface settings, see *Chapter 4 - Configuring IO Interfaces*.

---

## Getting Started

Depending on the hardware interfaces in your system, you can use one or more IO utilities to configure the Agilent IO Libraries for your system. This section shows how to get started using these utilities.

### Before You Begin Configuration

If you have Windows 95/98/Me and Windows 2000/NT environments on your system and you installed the IO Libraries on both environments, you will need perform the configuration procedures in this chapter twice – once on Windows 95/98/Me and once on Windows 2000/NT.

Before you can use an I/O interface with SICL or VISA, you must first configure the interface with the IO Config utility (located in the Agilent IO Libraries program folder). IO Config should be used exclusively to configure all interfaces used with SICL and VISA.

### Getting Started Using IO Configuration Utilities

To get started using the IO Configuration utilities:

- 1 Determine the IO interfaces for your system (GPIB, VXI, LAN, etc.).
- 2 As required, see the applicable section in *Chapter 4 - Configuring IO Interfaces* for guidelines to configure the interface(s). For example, see “Configuring GPIB Interfaces” for GPIB interfaces, etc.
- 3 See “Using IO Config” in this chapter for guidelines to use the IO Config utility to configure interfaces.
- 4 As required, see “Using VISA Assistant”, “Using VXI Resource Manager”, or “Using LAN Server” for configuration information.

## Using IO Config

This section gives guidelines to use the IO Libraries configuration utility IO Config. You can use IO Config to configure hardware interfaces (such as an 82350A GPIB card, etc.) for use with VISA and SICL on a Windows 95, Windows 98, Windows Me, Windows 2000, or Windows NT environment.

### NOTE

If any VISA or SICL applications are running when changes are made using IO Config, these changes will not take effect until all currently executing applications have completed.

## IO Config Requirements

The IO Config utility is used by the Agilent IO Libraries to configure instrument I/O hardware interfaces. An interface must be configured with IO Config before the interface can be used with the IO Libraries. You can configure all available interfaces with IO Config for use with the Agilent IO Libraries. With IO Config, you can also add, edit, or remove configuration entries for the interface(s) you specify.

IO Config is an interactive program that searches your system for installed interfaces that VISA and SICL support. You select the interface(s) you want to configure and IO Config selects default parameters required to configure the interface(s).

You can run IO Config at any time. However, you must first install an interface card in your system before you can configure the interface. IO Config will verify that an interface card is installed before a configuration entry will be added for the card.

You must have system administrator privileges on Windows 2000/NT to run IO Config. You may also need to reboot the computer if you add or modify interfaces with IO Config to load or update driver files for specific interfaces in the Windows kernel. IO Config will inform you if it is necessary to reboot your computer.

When you configure VISA with IO Config, the default configuration is to identify all VISA devices at application runtime. If you experience slow performance when running VISA applications, you may want to edit the VISA configuration to identify devices at configuration time (not at runtime). See the *VISA User's Guide* to edit the VISA configuration.



## Running IO Config

The purpose of IO Config is to configure an I/O interface for use with VISA or SICL. IO Config does this by associating a unique VISA and/or SICL name with a hardware interface. To begin this configuration:

- 1 Open IO Config by double-clicking the **IO Config** icon in the IO Libraries program group or by clicking the **Agilent IO Libraries Control** icon (blue IO icon on the Windows taskbar) and then selecting **Run IO Config**. The following figure shows a typical display.

### NOTE

If your system includes interfaces not shown on the typical display in the following figure, those interface names will automatically appear on the main screen. Follow the on-screen instructions to use IO Config to configure your system.

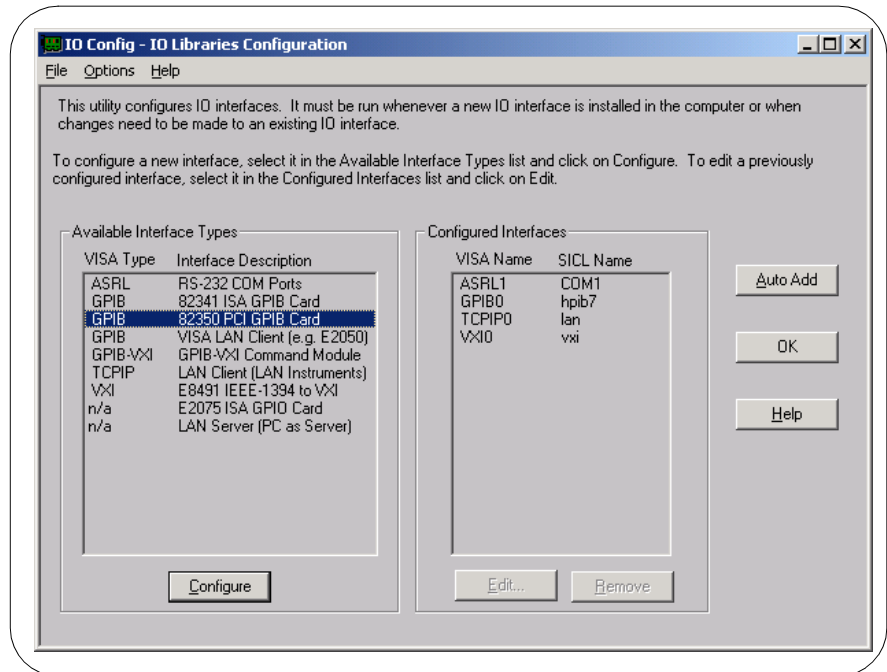

## Using IO Config

- 2 The above figure shows the available interface types (ASRL, GPIB, etc.) you can configure with IO Config and a description of each interface. In addition, the figure shows Configured Interfaces (interfaces already configured). Each configured interface has an associated VISA and/or SICL name.

In this figure, a configured ASRL (RS-232) interface has VISA name ASRL1 and SICL name COM1, a configured GPIB interface has VISA name GPIB0 and SICL name hpib7, etc. These names are used to open interface paths with the VISA `viOpen` command or the SICL `iopen` command. See the *Agilent VISA User's Guide for Windows* for information on VISA commands. See the *Agilent SICL User's Guide for Windows* for details on SICL commands.

- 3 To use IO Config to configure an interface, highlight the interface type and click the **C**onfigure button. The applicable configuration screen then appears. For example, for this figure, the 82350 PCI GPIB Card Configuration screen appears.
- 4 When the screen appears (see the following figure), set the VISA and SICL Interface Names and the Logical Unit and Bus Address values, as required. Then, click the **O**K button. If you have more than one 82350 card in your system, repeat for remaining cards. If you have questions about using IO Config for a specific interface, click the **H**elp button on the IO Config dialog box.

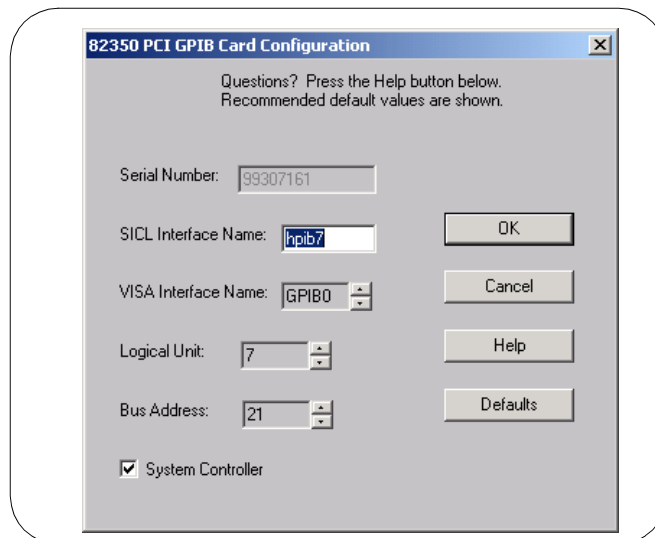

- 5 If you want IO Config to automatically configure new interfaces, click the **Auto Add** button. However, Auto Add will not add an 82341 ISA GPIB card, nor will it remove any interfaces that are no longer installed.
- 6 In most cases, you can use the automatic defaults. However, if you need to change a value, click the arrows next to the value's field. If there are no arrows, click the field and type in the value you want.
- 7 Note the name of the interface (such as `hpib7`, etc.) and the logical unit number of the interface for use in SICL applications, and the device address for use in VISA applications.
- 8 When you have finished configuring interfaces, click `OK` to store the changes.

## Example: Using IO Config

An **IO interface** can be defined as both a hardware interface and as a software interface. The purpose of the IO Config utility is to associate a unique interface name with a hardware interface.

The IO Libraries use an **Interface Name** or **Logical Unit Number** to identify an interface. This information is passed in the parameter string of the `viOpen` function call in a VISA program or in the `iopen` function call in a SICL program. IO Config assigns an Interface Name and Logical Unit Number to the interface hardware, as well as other necessary configuration values for an interface when the interface is configured.

The GPIB interface system in the following figure consists of a Windows PC with two 82350 GPIB cards connected to three GPIB instruments via GPIB cables. For this system, the IO Config utility has been used to assign GPIB card #1 a VISA name of "GPIB0" and a SICL name of "hpib7". IO Config has also been used to assign GPIB card #2 a VISA name of "GPIB1" and a SICL name of "hpib8". With these names assigned to the interfaces, the VISA/SICL addressing is as shown in the figure.

Since unique names have been assigned by IO Config, you can use the VISA `viOpen` command to open the IO paths to the GPIB instruments as shown in the above figure. Or, you can use the SICL `iopen` command to open the IO paths shown. See the *Agilent VISA User's Guide* for details on VISA commands. See the *Agilent SICL User's Guide for Windows* for details on SICL commands.

# Using IO Configuration Utilities

## Using IO Config

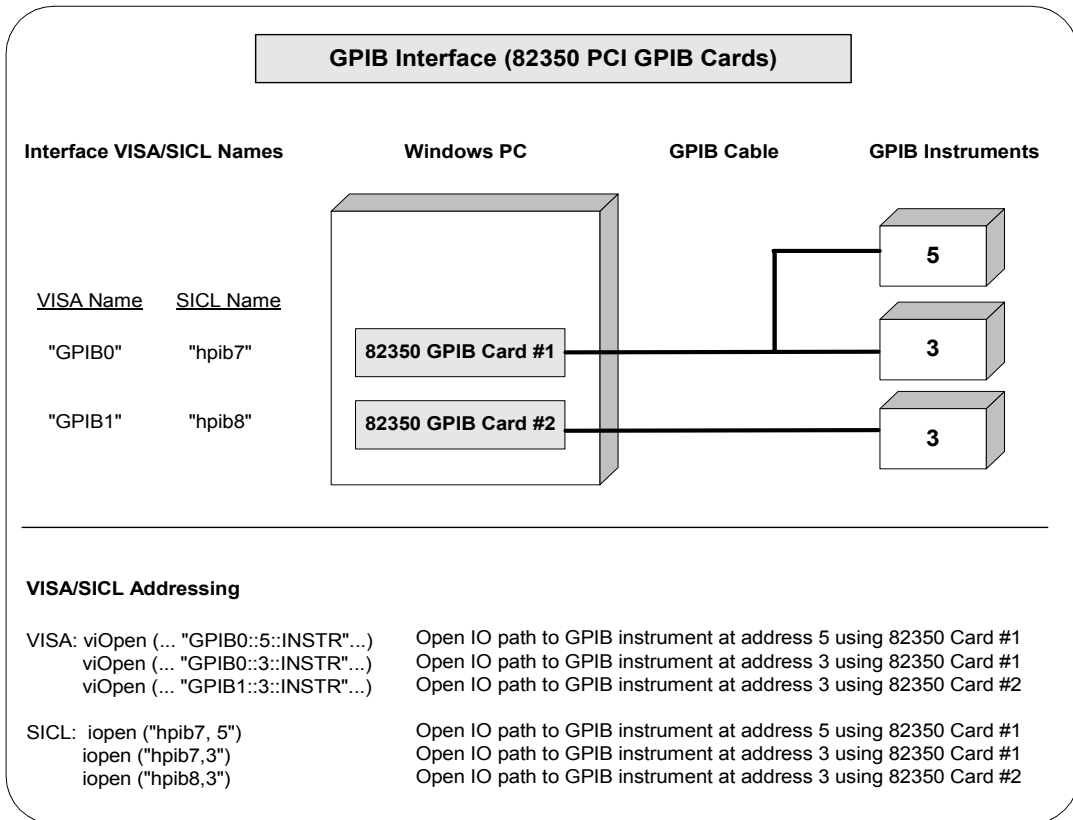

---

## Using VISA Assistant

VISA Assistant is an application program that uses the IO Libraries to communicate with and to control VXI, GPIB, and serial Instruments.

### VISA Assistant Overview

VISA Assistant can automatically detect and assign VXI*plug&play* instrument drivers to instruments. VISA Assistant can also be used to send and receive strings to instruments which support formatted I/O. For other instruments, VISA Assistant allows you to read and write memory areas. VISA Assistant also describes attributes that are associated with an instrument.

### Running VISA Assistant

To run VISA Assistant, either click **Start | Programs | Agilent IO Libraries | VISA Assistant** or click the Agilent IO Libraries Control and then click **Run VISA Assistant**. A typical display showing the system Instrument View follows. For information on using VISA Assistant, click the **H**elp menu button.

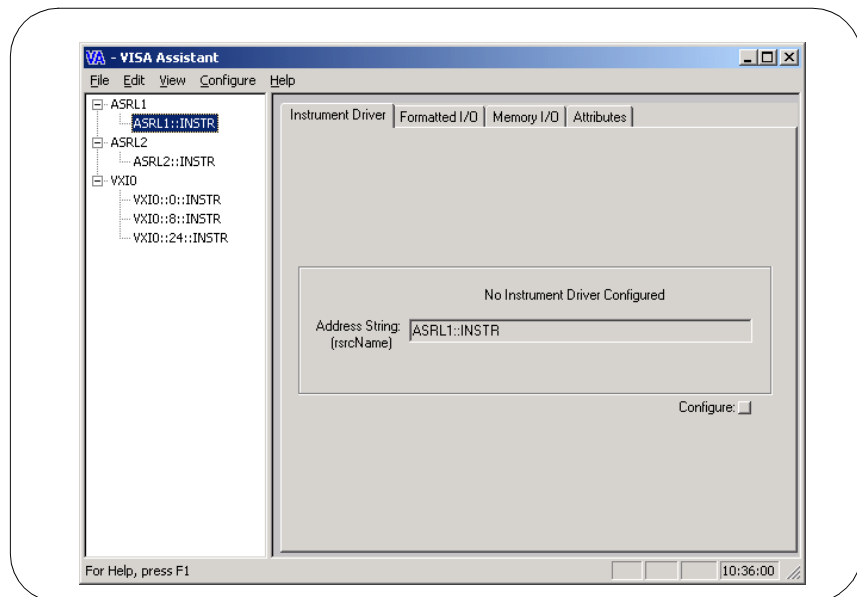

## Using the VXI Resource Manager

If your system includes an E8491 IEEE-1394 PC Link to VXI interface, you can view the output of the VXI Resource Manager to determine if your system is properly configured.

### VXI Resource Manager Overview

The VXI Resource Manager initializes and prepares the VXI system for use. The VXI Resource Manager will run when:

- VXI mainframe power is applied or cycled
- The E8491 Reset button is pressed
- It is activated from the IO Config utility
- It is activated from Agilent IO Libraries Control icon
- Computer is rebooted

In VXI systems with multiple E8491s, individual mainframes can be turned off without affecting other mainframes in the system. When a mainframe is turned on, the Resource Manager reconfigures the mainframe.

#### **NOTE**

The Agilent IO Libraries Control utility must be running to enable the VXI Resource Manager to run. The VXI Resource Manager is installed when the E8491 interface is configured using IO Config. Click the blue IO icon on the taskbar to access the IO Libraries Control utility.

If the IO Libraries Control icon is not visible, you can display the icon by clicking

The displays in this section are from Windows 2000. Displays for Windows 95, Windows 98, Windows Me, or Windows NT may be slightly different.

## Opening VXI Resource Manager

The easiest way to view this output is to use the IO Config utility to run the VXI Resource Manager. Click **Start | Programs | Agilent IO Libraries | IO Config** OR click the Agilent IO Libraries Control icon and select **Run IO Config** to display the IO Config main panel. Highlight the **E8491 IEEE 1394 to VXI** entry. Then, click **Configure**.

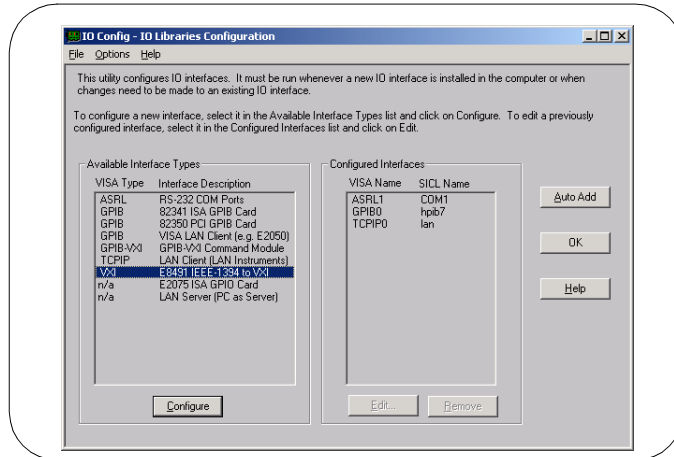

On the **E8491 VXI Board Configuration** screen, change the settings for your system, as required. When complete, click **OK** to re-display the main screen.

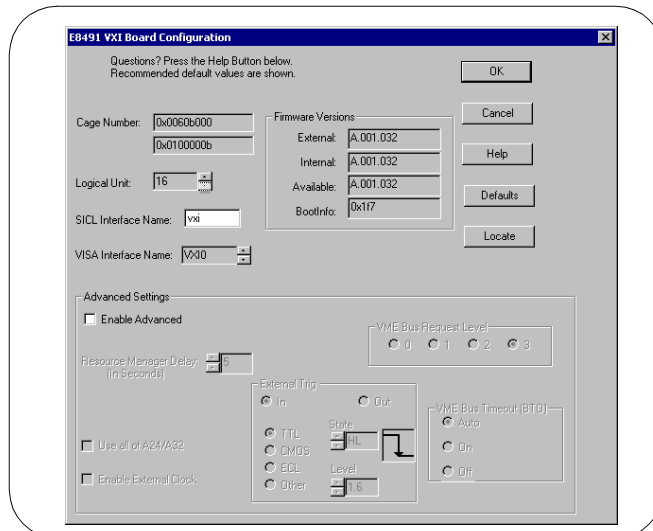

## Using IO Configuration Utilities

### Using the VXI Resource Manager

On the main screen, highlight the `vxi` entry and then click **Edit** to re-display the **E8491 VXI Board Configuration** screen.

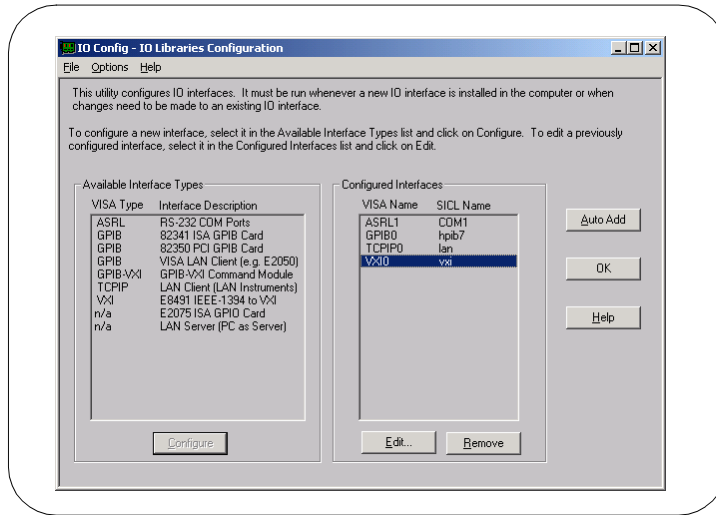

Click **Edit VISA Config...** on this screen to display the **Show Devices** screen.

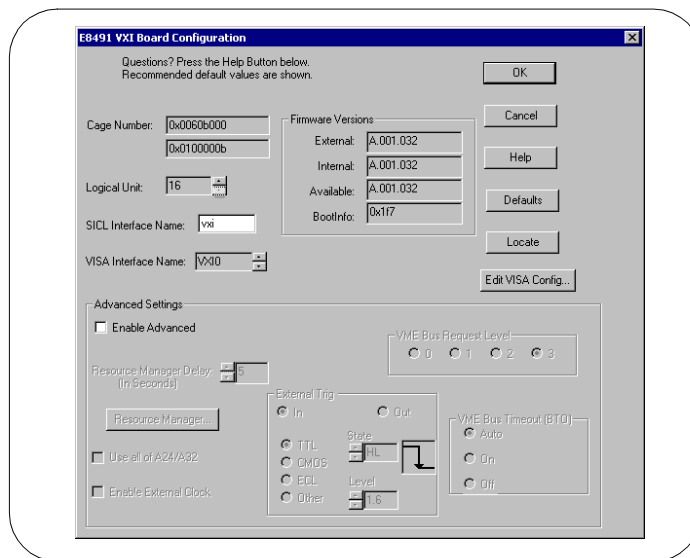



On the **Show Devices** screen, you can add or remove devices manually or auto-add devices. Click **OK** when you have added/deleted devices manually.



**NOTE**

If the **Identify devices at run-time** box is **not** checked, the only devices that VISA can open are the ones listed in the **Devices present on interface VXIn** box. You can add or remove devices from this box using the **A**dd device or **R**emove device buttons, respectively.

If the **Identify devices at run-time** box is checked, at runtime VISA will look for all devices so entries are not required in the **Devices present on interface VXIn** box.

## Displaying VXI Resource Manager Output

If an E8491 has previously been installed and configured with IO Config, the VXI Resource Manager will automatically run every time Windows starts. If you change the E8491 configuration in IO Config, the VXI Resource Manager will run automatically (after a 5-second delay) when IO Config is closed.

After the VXI Resource Manager has run, you can view its output. To display the **Resource Manager** screen, click the Agilent IO Libraries Control icon on the taskbar and select **Edit VXI Resource Manager**. See the following figure for a typical display.

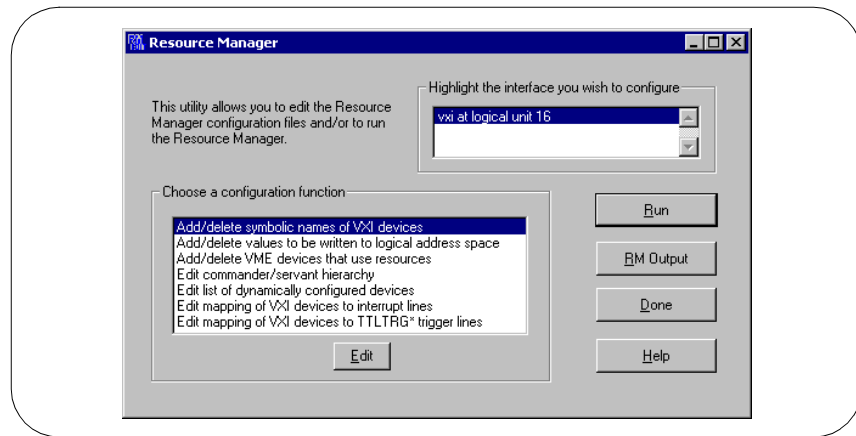

To view the system configuration (the VXI Resource Manager output), click **RM Output**. The following figure shows a part of a typical display.

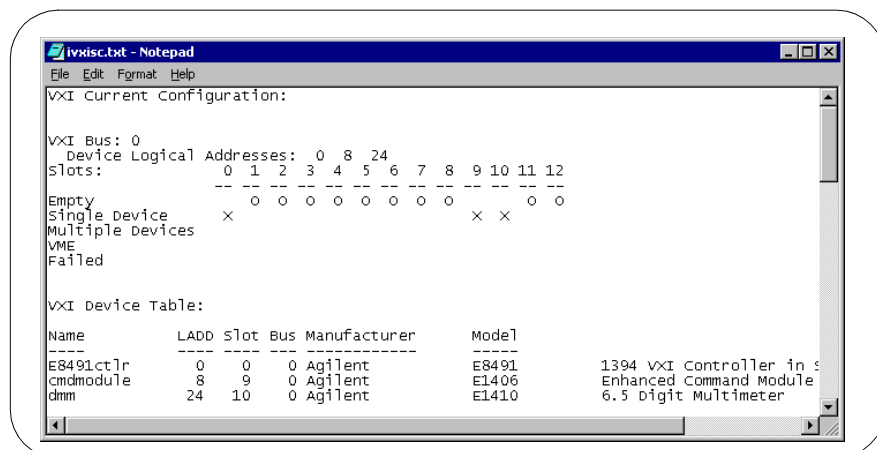

## Using the LAN Server

If you configured the LAN server on this system using IO Config, you must now start the LAN server process on this system.

### Starting the LAN Server

- To start the LAN server, you can *either* restart (reboot) this system now or manually start the LAN server process on this system.
- To manually start the LAN server process on the system after the LAN server has been configured using IO Config, click the LAN Server icon in the Agilent IO Libraries program group.
- The LAN server is now running. You can now minimize the LAN Server window so that the LAN Server process is listed on the Windows taskbar.

### Stopping the LAN Server

To stop the LAN server process from running on the system:

- 1 Open the LAN Server window on the screen and move the cursor into the LAN Server window.
- 2 Press **Ctrl+C** or click the **Close** box to close the window. The LAN server process is stopped.



---

## **Configuring I/O Interfaces**

---

## Configuring I/O Interfaces

This chapter gives guidelines to use IO configuration utilities to configure I/O interfaces, including:

- Configuring GPIB Interfaces
- Configuring VXI Interfaces
- Configuring LAN Interfaces
- Configuring Other Interfaces

**NOTE**

See *Chapter 3 - Using IO Configuration Utilities* for information on using IO Configuration utilities (IO Config, VISA Assistant, VXI Resource Manager, and LAN Server) to configure I/O interfaces.

---

## Configuring GPIB Interfaces

This section gives guidelines to use the IO Config utility to configure GPIB interfaces, including:

- GPIB Interface Overview
- Configuring GPIB (82350 PCI) Interfaces
- Configuring GPIB (82341 ISA) Interfaces

### GPIB Interfaces Overview

As shown in the following figure, a typical GPIB interface consists of a Windows PC with one or more GPIB cards (PCI and/or ISA) cards installed in the PC and one or more GPIB instruments connected to the GPIB cards via GPIB cable. I/O communication between the PC and the instruments is via the GPIB cards and the GPIB cable. This figure shows GPIB instruments at addresses 3 and 5.

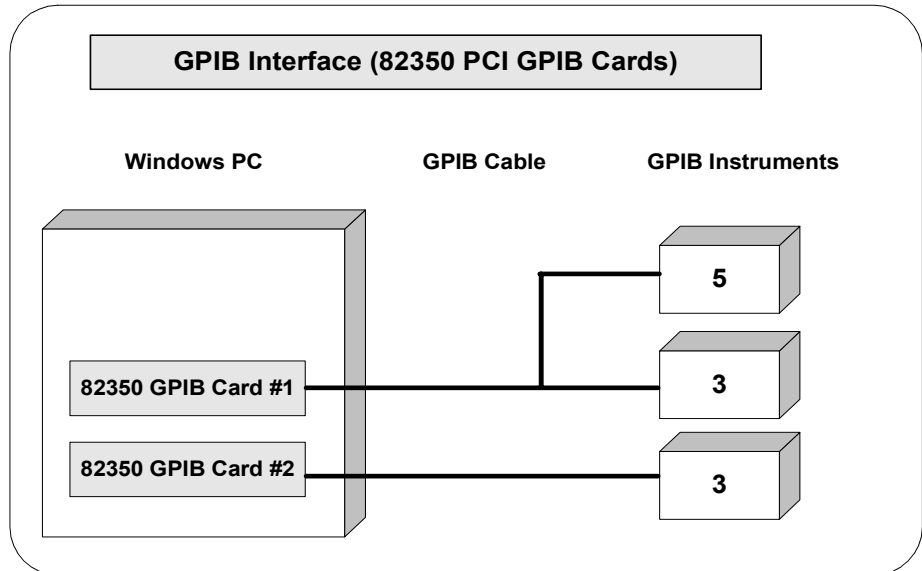

## Configuring GPIB (82350 PCI) Interfaces

An **IO interface** can be defined as both a hardware interface and as a software interface. The purpose of the IO Config utility is to associate a unique interface name with a hardware interface.

The IO Libraries use an **Interface Name** or **Logical Unit Number** to identify an interface. This information is passed in the parameter string of the **viOpen** function call in a VISA program or in the **iopen** function call in a SICL program. IO Config assigns an Interface Name and Logical Unit Number to the interface hardware, as well as other necessary configuration values for an interface when the interface is configured.

Using IO Config to  
Configure GPIB  
(82350) Interfaces

To configure GPIB (82350) interfaces using the IO Config utility, click the Agilent IO Libraries Control icon (blue icon on the Windows taskbar) and click **Run IO Config**. When the main screen appears, highlight the **GPIB 82350 PCI GPIB Card** menu item (see the following figure) and then click the **Configure** button.

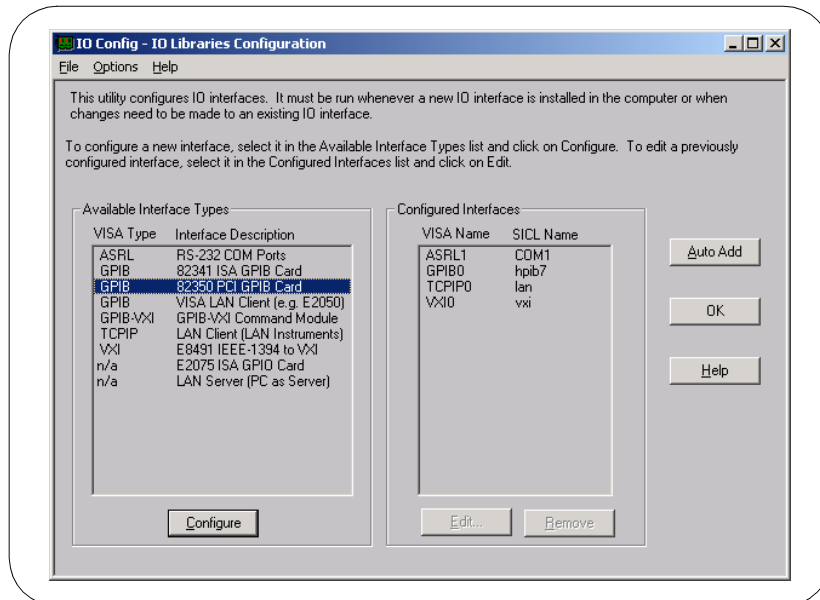



When the **82350 PCI GPIB Card Configuration** screen appears (see the following figure), set the VISA and SICL Interface Names and the Logical Unit and Bus Address values as required. Then, click the **OK** button. If you have more than one 82350 card in your system, repeat for remaining cards.

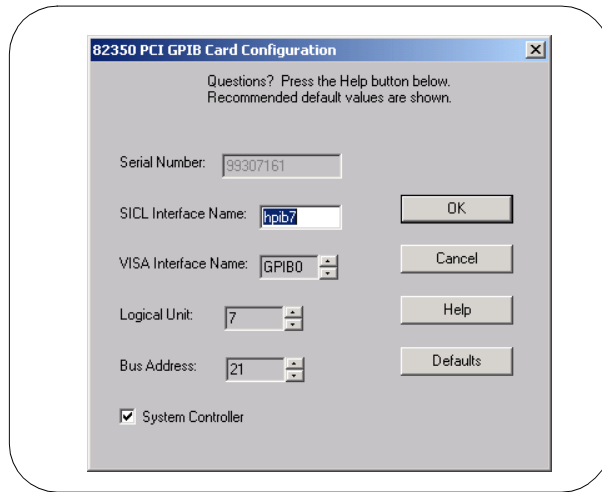

**NOTE**

After the system is configured, this screen may also display an **Edit VISA Config...** button. Clicking this button allows you to manually configure the interface as desired. See the *IO Libraries Readme* file for details.

Example:  
Configuring GPIB  
(82350) Interface

The GPIB interface system in the following figure consists of a Windows PC with two 82350 GPIB cards connected to three GPIB instruments via GPIB cables. For this system, the IO Config utility has been used to assign GPIB card #1 a VISA name of “GPIB0” and a SICL name of “hpib7”. IO Config has also been used to assign GPIB card #2 a VISA name of “GPIB1” and a SICL name of “hpib8”. With these names assigned to the interfaces, the VISA/SICL addressing is as shown in the figure.

Since unique names have been assigned by IO Config, you can use the VISA `viOpen` command to open the I/O paths to the GPIB instruments as shown in the above figure. Or, you can use the SICL `iopen` command to open the I/O paths shown. See the *Agilent VISA User's Guide* for details on VISA commands. See the *Agilent SICL User's Guide for Windows* for details on SICL commands.

# Configuring I/O Interfaces

## Configuring GPIB Interfaces

### GPIB Interface (82350 PCI GPIB Cards)

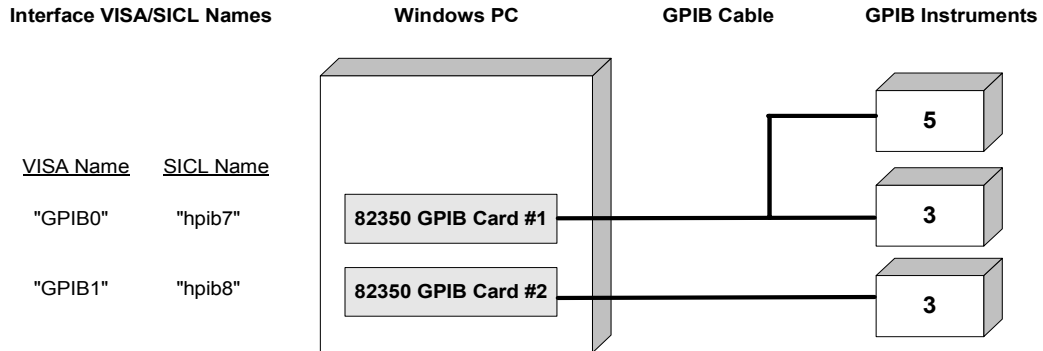

#### VISA/SICL Addressing

VISA: viOpen (... "GPIB0::5::INSTR"...)	Open IO path to GPIB instrument at address 5 using 82350 Card #1
viOpen (... "GPIB0::3::INSTR"...)	Open IO path to GPIB instrument at address 3 using 82350 Card #1
viOpen (... "GPIB1::3::INSTR"...)	Open IO path to GPIB instrument at address 3 using 82350 Card #2
SICL: iopen ("hplib7, 5")	Open IO path to GPIB instrument at address 5 using 82350 Card #1
iopen ("hplib7,3")	Open IO path to GPIB instrument at address 3 using 82350 Card #1
iopen ("hplib8,3")	Open IO path to GPIB instrument at address 3 using 82350 Card #2

## Configuring GPIB (82341 ISA) Interfaces

An **IO interface** can be defined as both a hardware interface and as a software interface. The purpose of the IO Config utility is to associate a unique interface name with a hardware interface.

The IO Libraries use an **Interface Name** or **Logical Unit Number** to identify an interface. This information is passed in the parameter string of the **viOpen** function call in a VISA program or in the **iopen** function call in a SICL program. IO Config assigns an Interface Name and Logical Unit Number to the interface hardware, as well as other necessary configuration values for an interface when the interface is configured.

Using IO Config to  
Configure GPIB  
(82341) Interfaces

To configure GPIB (82341) interfaces using the IO Config utility, click the Agilent IO Libraries Control icon (blue icon on the Windows taskbar) and click **Run IO Config**. When the main screen appears, highlight the **GPIB 82341 PCI GPIB Card** menu item (see the following figure) and then click the **Configure** button.

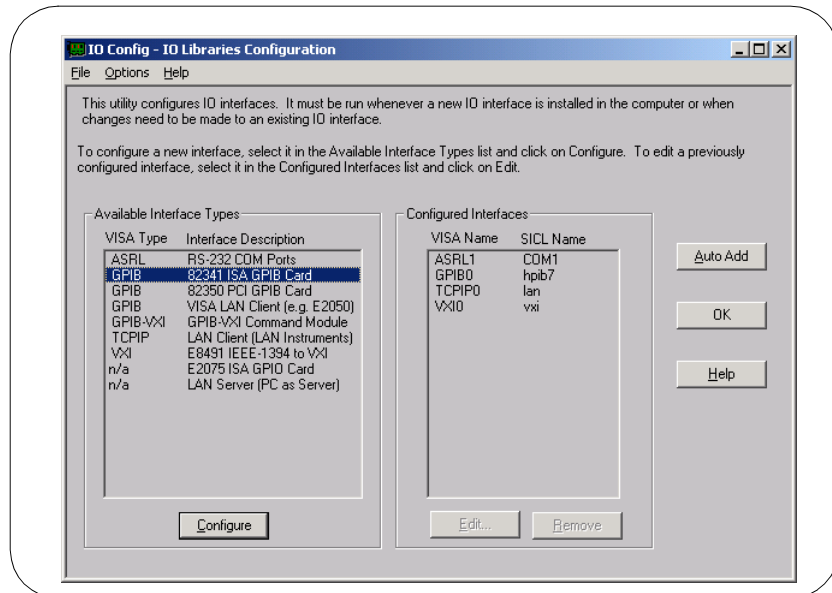

## Configuring I/O Interfaces

### Configuring GPIB Interfaces

When the **82341 ISA GPIB Card Configuration** screen appears, set the VISA and SICL Interface Names and the Logical Unit, IRQ Line, and Bus Address values as required. Then, click the **OK** button. If you have more than one 82341 card in your system, repeat for remaining cards.

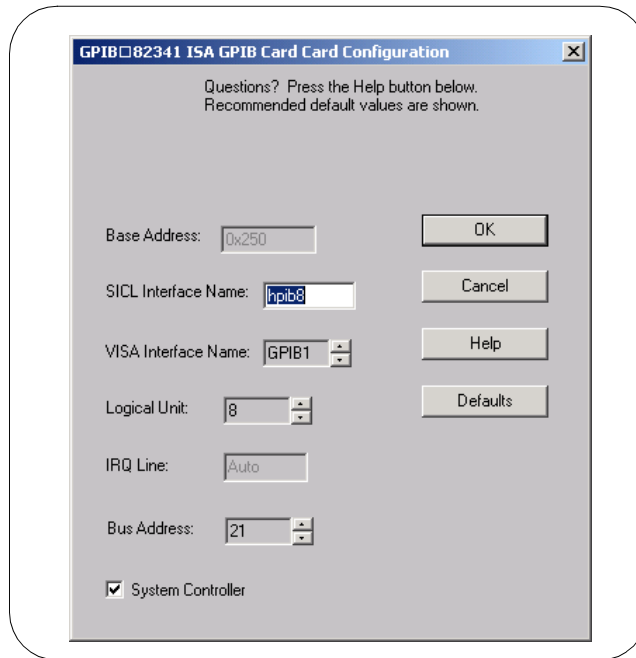

#### NOTE

After the system is configured, this screen may also display an **Edit VISA Config...** button. Clicking this button allows you to manually configure the interface as desired. See the IO Libraries Readme file for details.

#### Example: Configuring GPIB (82341) Interface

The GPIB interface system in the following figure consists of a Windows PC with two 82341 GPIB cards connected to three GPIB instruments via GPIB cables. For this system, the IO Config utility has been used to assign GPIB card #1 a VISA name of "GPIB0" and a SICL name of "hplib7". IO Config has also been used to assign GPIB card #2 a VISA name of "GPIB1" and a SICL name of "hplib8". With these names assigned to the interfaces, the VISA/SICL addressing is as shown in the figure.

Since unique names have been assigned by IO Config, you can use the VISA `viOpen` command to open the I/O paths to the GPIB instruments as shown in the above figure. Or, you can use the SICL `iopen` command to open the I/O paths shown. See the *Agilent VISA User's Guide* for details on VISA commands. See the *Agilent SICL User's Guide for Windows* for details on SICL commands.

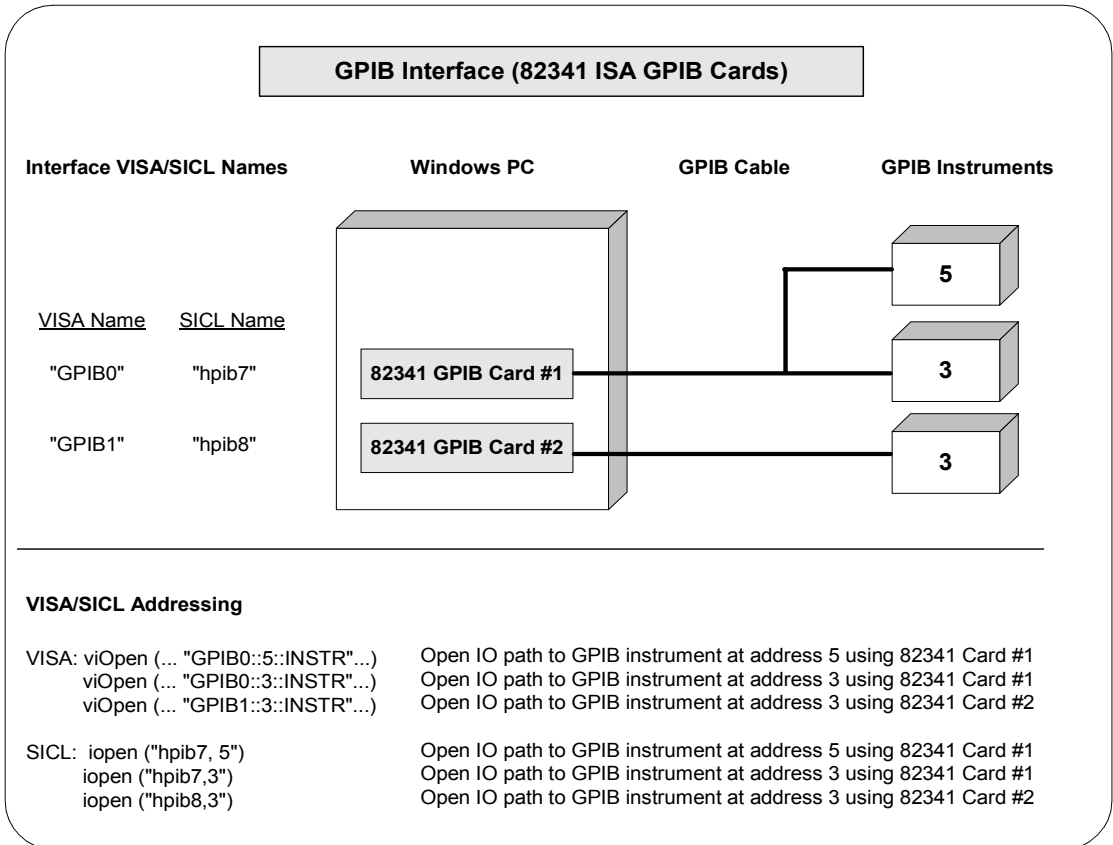

---

## Configuring VXI Interfaces

This section gives guidelines to use the IO Config utility to configure VXI interfaces, including:

- VXI Interfaces Overview
- Configuring GPIB-VXI (E1406A) Interfaces
- Configuring VXI (E8491B) Interfaces

### VXI Interfaces Overview

As shown in the following figure, a typical VXI interface consists of one of two main hardware configurations: E1406A Command Module or E8491B IEEE-1394 to VXI Module.

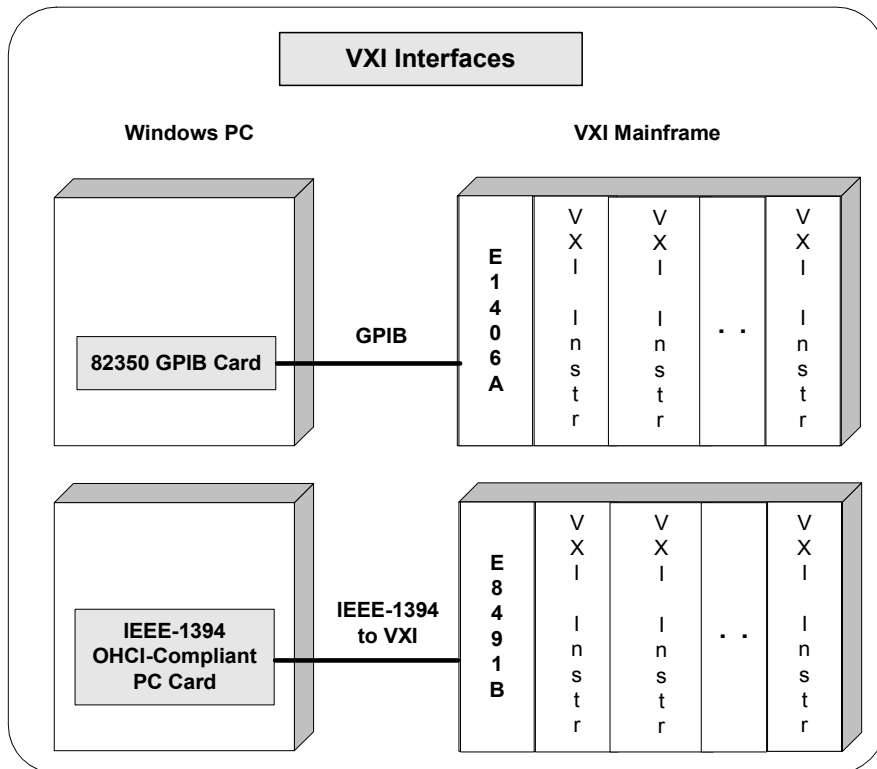

- The **E1406A Command Module** version consists of a Windows PC with an 82350 (or equivalent) GPIB card and a VXI mainframe with an E1406A Command Module and one or more VXI instruments. I/O communication from the PC to the VXI instruments is via the GPIB card, GPIB cable, and E1406A Command Module.
- The **E8491B Module** version consists of a Windows PC with an IEEE-1394 OHCI-Compliant (FireWire) PC card and a VXI mainframe with an E8491B IEEE-1394 to VXI Module and one or more VXI instruments. I/O communication from the PC to the VXI instruments is via the PC card, IEEE-1394 to VXI cable, and E8491B Module.

## Configuring GPIB-VXI (E1406A) Interfaces

An **IO interface** can be defined as both a hardware interface and as a software interface. The purpose of the IO Config utility is to associate a unique interface name with a hardware interface.

The IO Libraries use an **Interface Name** or **Logical Unit Number** to identify an interface. This information is passed in the parameter string of the **viOpen** function call in a VISA program or in the **iopen** function call in a SICL program. IO Config assigns an Interface Name and Logical Unit Number to the interface hardware, as well as other necessary configuration values for an interface when the interface is configured.

### Using IO Config to Configure GPIB-VXI (E1406A) Interfaces

To configure GPIB-VXI (E1406A Command Module) interfaces using the IO Config utility, click the Agilent IO Libraries Control icon (blue icon on the Windows taskbar) and click **Run IO Config**. When the main screen appears, highlight the **GPIB-VXI** menu item (see the following figure) and then click the **Configure** button.

When the **GPIB-VXI Command Module Configuration** screen appears, set the VISA Interface Name, GPIB Interface Name, and GPIB Primary Address as required. Then, click the **OK** button.

#### **NOTE**

After the system is configured, this screen may also display an **Edit VISA Config...** button. Clicking this button allows you to manually configure the interface as desired. See the IO Libraries Readme file for details.

## Configuring I/O Interfaces

### Configuring VXI Interfaces

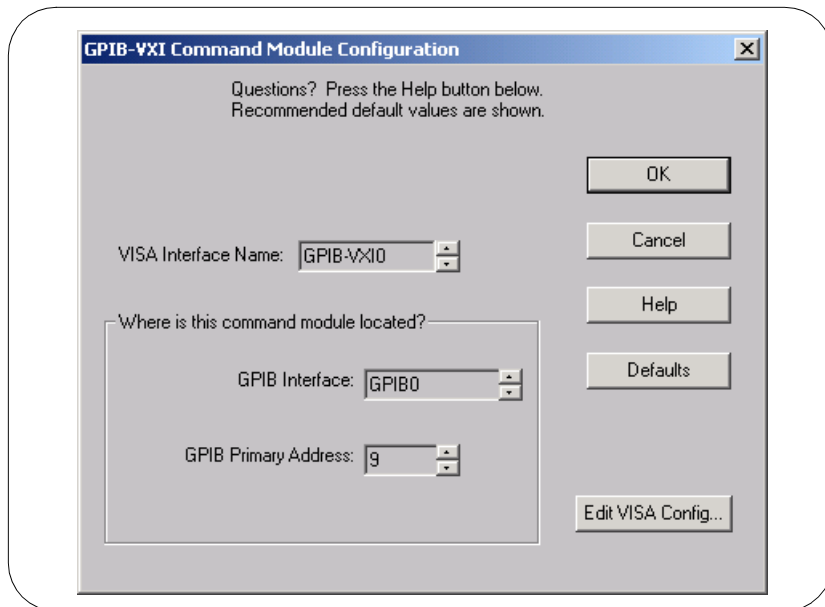
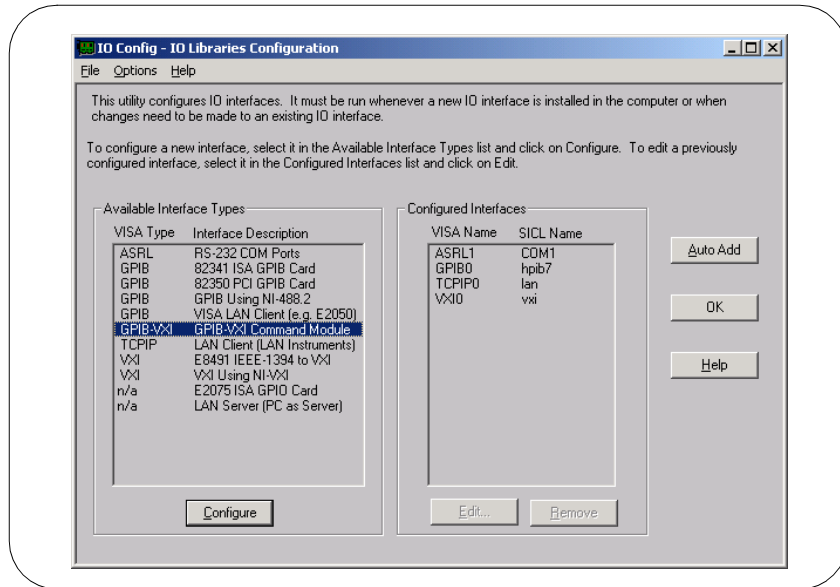



**Example:  
 Configuring  
 GPIB-VXI (E1406A)  
 Interface**

The GPIB-VXI interface system in the following figure consists of a Windows PC with an 82350 GPIB card that connects to an E1406A Command Module in a VXI Mainframe. The VXI mainframe includes one or more VXI instruments. When the IO Libraries were installed, a GPIB-VXI driver with GPIB address 9 was also installed and the E1406A was configured for primary address 9 and logical address (LA) 0. The three VXI instruments shown have logical addresses 8, 16, and 24.

The IO Config utility has been used to assign the GPIB-VXI driver a VISA Name of "GPIB-VXI0" and to assign the 82350 GPIB card a VISA name of "GPIB0" and SICL name of "hplib7". With these names assigned to the interfaces, the VISA addressing is as shown in the figure.

For information on the E1406A Command Module, see the *Agilent E1406A Command Module User's Guide*. For information on VXI instruments, see the applicable *VXI instrument User's Guide*. See the *Agilent VISA User's Guide* for details on VISA commands.

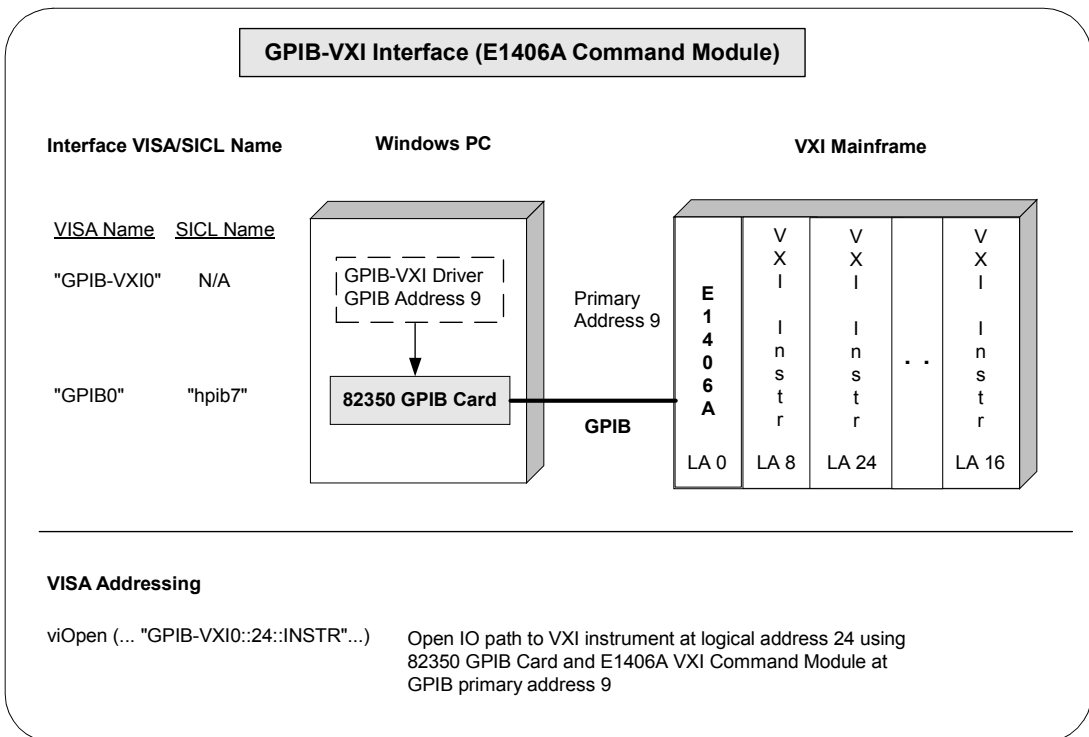

## Configuring VXI (E8491B) Interfaces

An **IO interface** can be defined as both a hardware interface and as a software interface. The purpose of the IO Config utility is to associate a unique interface name with a hardware interface.

The IO Libraries use an **Interface Name** or **Logical Unit Number** to identify an interface. This information is passed in the parameter string of the **viOpen** function call in a VISA program or in the **iOpen** function call in a SIDL program. IO Config assigns an Interface Name and Logical Unit Number to the interface hardware, as well as other necessary configuration values for an interface when the interface is configured.

### Using IO Config to Configure VXI (E8491B) Interfaces

To configure VXI (E8491B module) interfaces using the IO Config utility, click the Agilent IO Libraries Control icon (blue icon on the Windows taskbar) and click **Run IO Config**. When the main screen appears, highlight the **VXI E8491 IEEE-1394 to VXI** menu item (see the following figure) and click the **Configure** button.

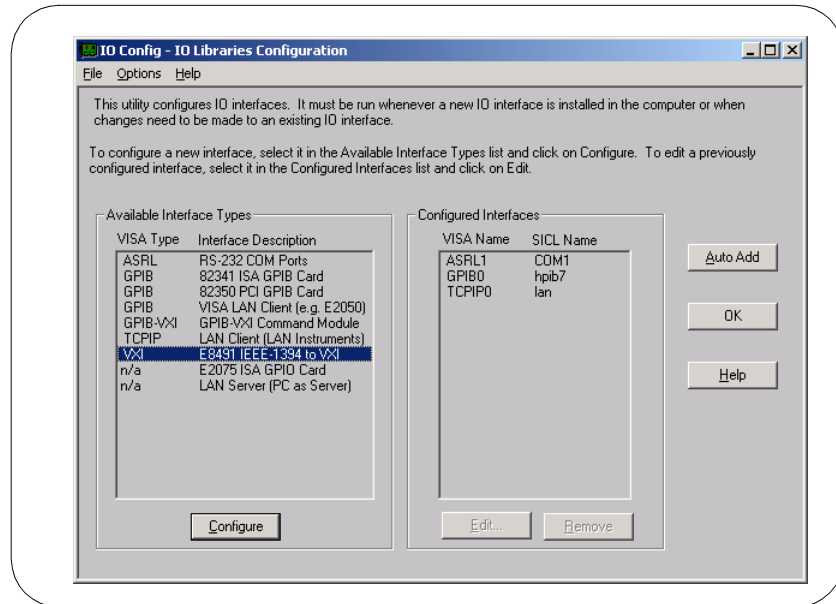

When the **E8491 VXI Board Configuration** screen appears, set the VISA Interface Name, as required. Then, click the **OK** button.

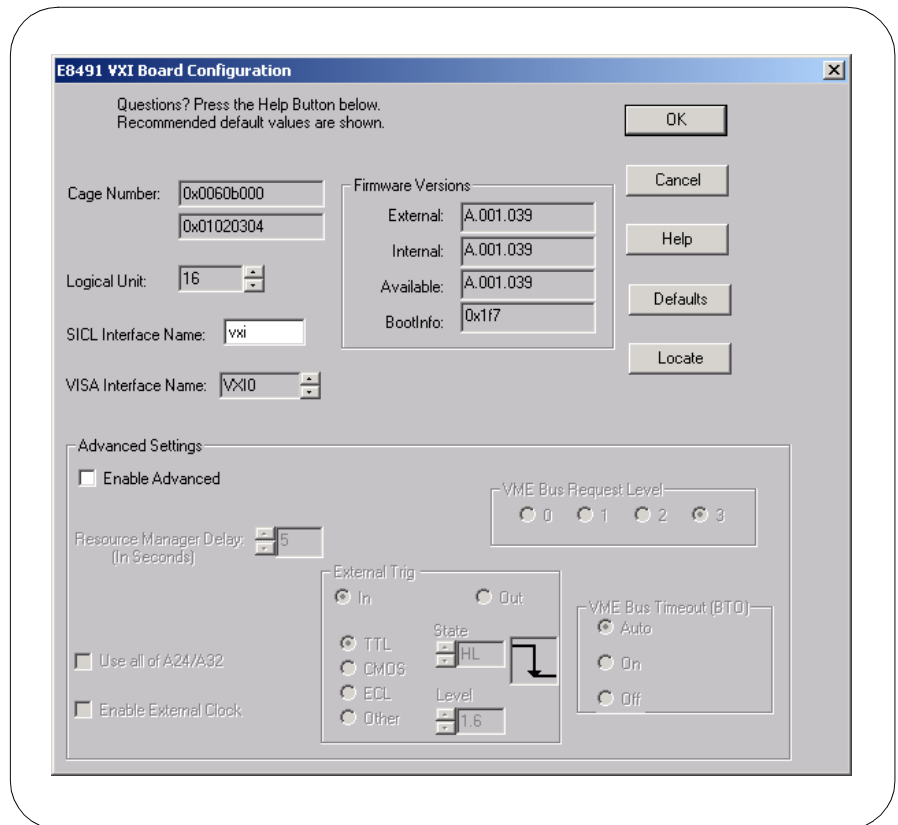

**NOTE**

After the system is configured, this screen may also display an **Edit VISA Config...** button. Clicking this button allows you to manually configure the interface as desired. See the IO Libraries Readme file for details.

## Configuring I/O Interfaces

### Configuring VXI Interfaces

#### Example: Configuring VXI (E8491B) Interfaces

The VXI interface system in the following figure consists of a Windows PC with an E8491 PC card that connects to an E8491B IEEE-1394 to VXI Module in a VXI Mainframe. The VXI mainframe includes one or more VXI instruments. For this system, the three VXI instruments shown have logical addresses 8, 16, and 24.

The IO Config utility has been used to assign the E8491 PC card a VISA name of "VXI0" and SICL name of "vxi". With these names assigned to the interface, you can use the VISA/SICL addressing shown in the figure.

For information on the E8491B module, see the *Agilent E8491B User's Guide*. For information on VXI instruments, see the applicable *VXI Instrument User's Guide*. See the *Agilent VISA User's Guide* for details on VISA commands. See the *Agilent SICL User's Guide for Windows* for details on SICL commands.

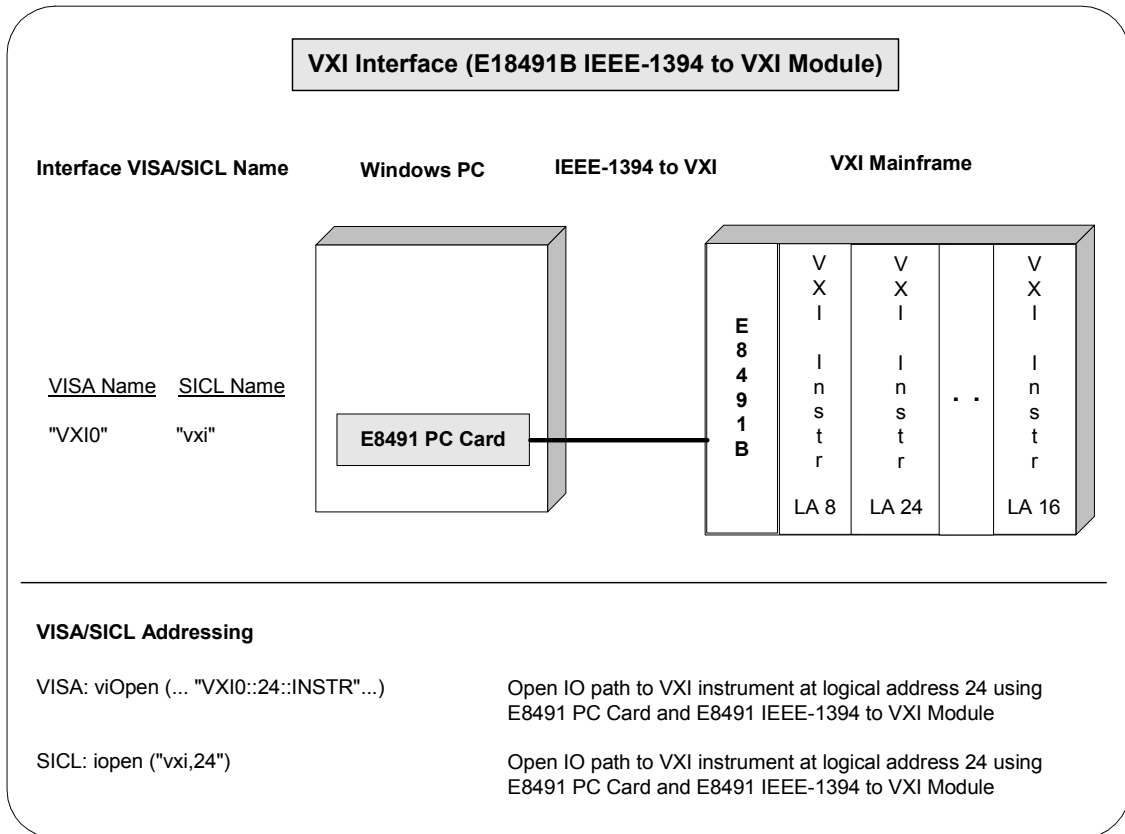

---

## Configuring LAN Interfaces

This section gives guidelines to use the IO Config utility to configure LAN interfaces, including:

- LAN Interfaces Overview
- Configuring LAN Client Interfaces
- Configuring VISA LAN Client Interfaces
- Configuring LAN Server Interfaces

### LAN Interfaces Overview

This section gives guidelines to use the Agilent IO Libraries to configure instruments over a LAN (Local Area Network). A LAN is a way to extend the control of instrumentation beyond the limits of typical instrument interfaces. To communicate over the LAN, you must first configure the LAN Client interface.

#### LAN Client/Server Model

The LAN software provided with the Agilent IO Libraries allows instrumentation control over a LAN. Using standard LAN connections, instruments can be controlled from computers that do not have special interfaces for instrument control.

The LAN software uses the **client/server model** of computing. Client/server computing refers to a model where an application (the **client**) does not perform all necessary tasks of the application itself. Instead, the client makes requests of another computing device (the **server**) for certain services.

#### LAN Hardware Architecture

As shown in the following figure, a LAN client (such as a Series 700 HP-UX workstation or a Windows 95/98/Me/NT/2000 PC) makes VISA requests over the network to a LAN server (such as a Series 700 HP-UX workstation, a Windows 95/98/Me/NT/2000 PC, or an E2050 LAN/GPIB Gateway).

The LAN server is connected to the instrumentation or devices to be controlled. Once the LAN server has completed the requested operation on the instrument or device, the LAN server sends a reply to the LAN client. This reply contains requested data and status information that indicates whether or not the operation was successful. The LAN server acts as a **gateway** between the LAN software that the client system supports and the instrument-specific interface that the device supports.

Configuring I/O Interfaces  
**Configuring LAN Interfaces**

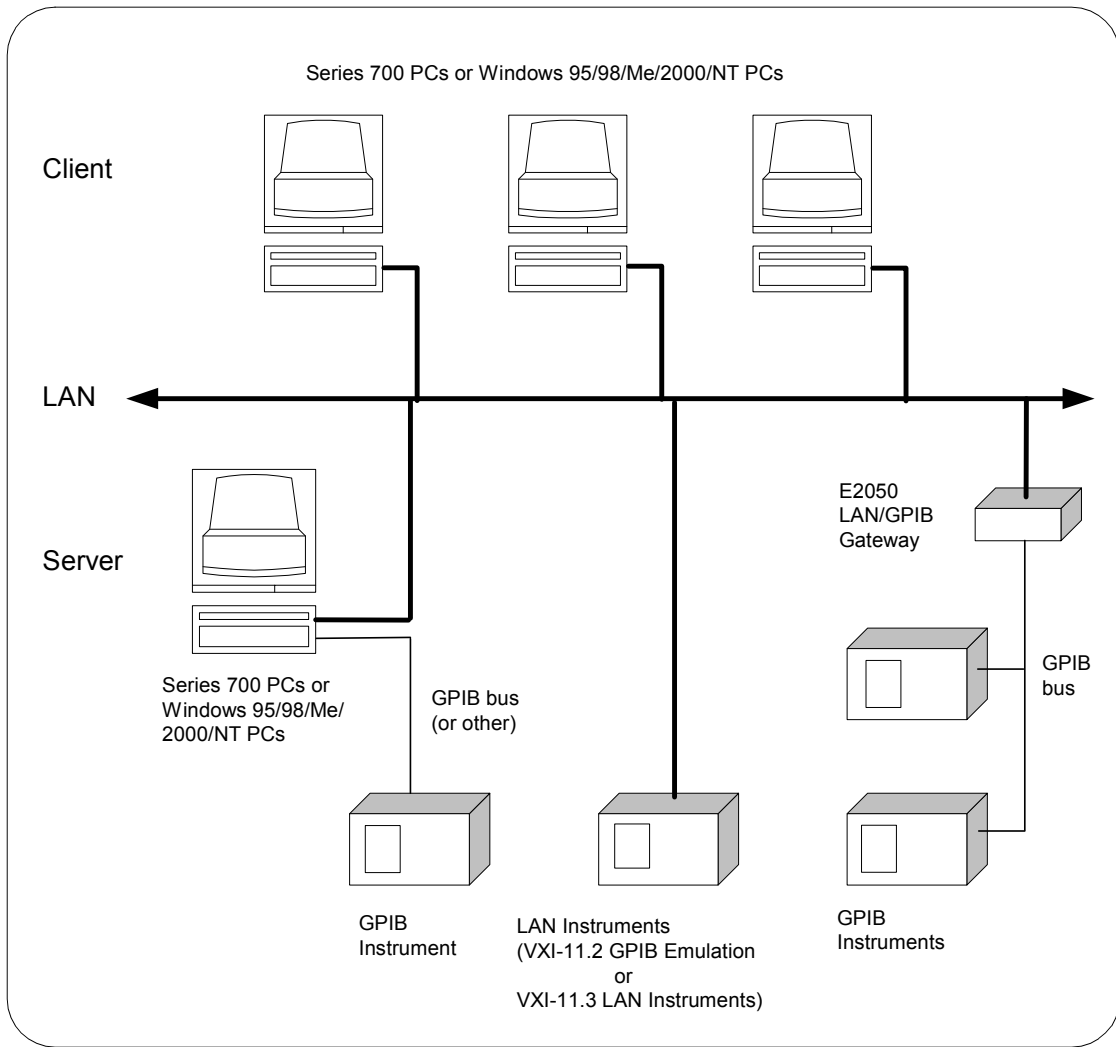

**LAN Software Architecture**

As shown in the following figure, the client system contains the LAN client software and the LAN software (TCP/IP) needed to access the server (gateway). The gateway contains the LAN server software, LAN (TCP/IP) software, and the instrument driver software needed to communicate with the client and to control the instruments or devices connected to the gateway.

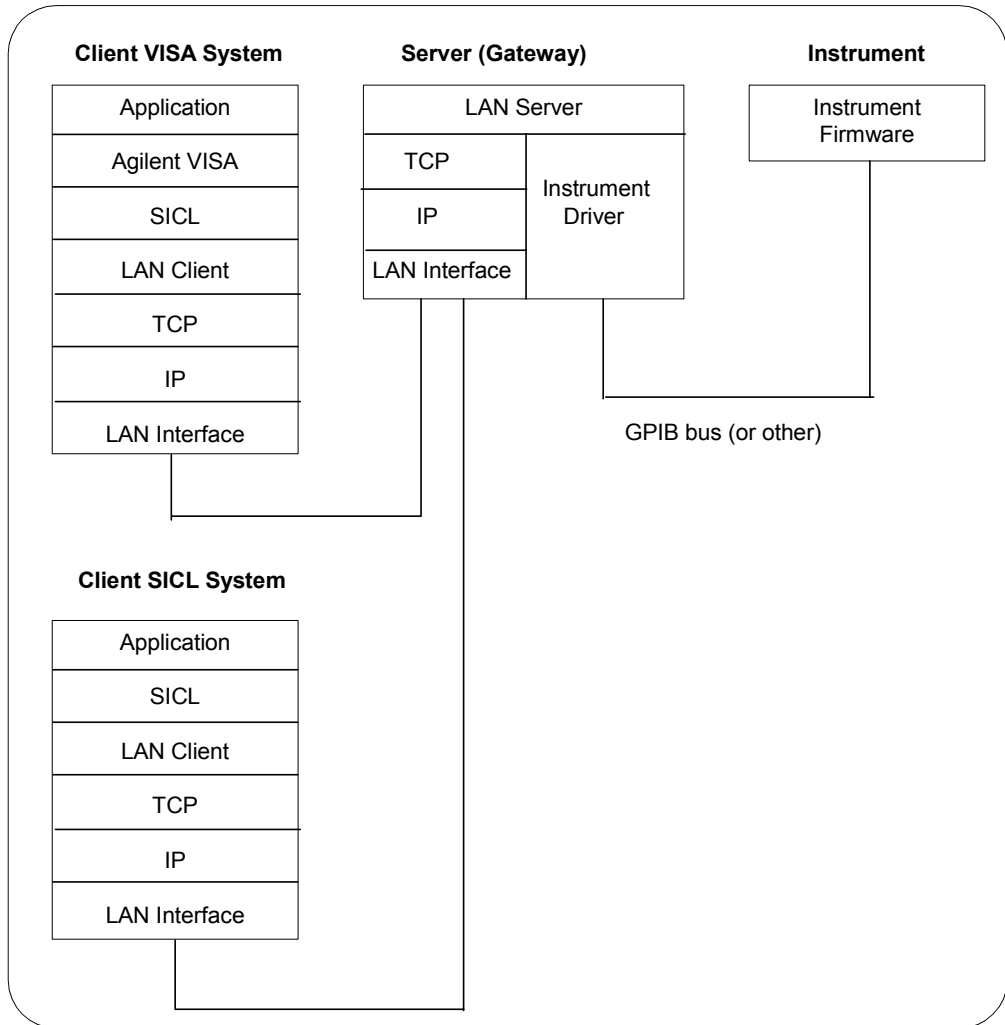

## Configuring LAN Interfaces

The LAN software is built on top of standard LAN networking protocols. There are two LAN networking protocols provided with the Agilent IO Libraries software. You can use one or both of these protocols when configuring your systems (via Agilent IO Libraries configuration) to use VISA and SICL over LAN.

- **SICL-LAN Protocol** is a networking protocol developed by Agilent that is compatible with all VISA LAN products. This LAN networking protocol is the default choice in the Agilent IO Libraries configuration when configuring the LAN client. The SICL LAN protocol on HP-UX 10.20, Windows 95/98/Me/2000/NT supports VISA operations over LAN to GPIB interfaces.
- **VXI-11 (TCP/IP Instrument Protocol)** is a networking protocol developed by the VXIbus Consortium based on the SICL LAN Protocol that permits interoperability of LAN software from different vendors who meet the VXIbus Consortium standards.

When using either of these networking protocols, the LAN software uses the TCP/IP protocol suite to pass messages between the LAN client and the LAN server. The server accepts device I/O requests over the network from the client and then proceeds to execute those I/O requests on a local interface (GPIB, etc.).

By default, the LAN Client supports both protocols by automatically detecting the protocol the server is using. When a VISA `viOpen` or SICL `iOpen` call is performed, the LAN Client driver first tries to connect using the SICL-LAN protocol. If that fails, the driver will try to connect using the VXI-11 protocol.

If you want to control the protocol used, you can configure more than one LAN Client interface and set each interface to a different protocol. The protocol used will then depend on the interface you are connecting through. Thus, you can have more than one SICL-LAN and one VXI-11 protocols for your system.

In VISA, the protocol used is determined by the configuration settings and cannot be changed programatically. In SICL, the programmer can override the configuration settings by specifying the protocol in the `iOpen` string. Some examples are:



- `iopen("lan[machineName]:hpiB7,1")` will use the configured default protocol. If AUTO is configured, SICL-LAN protocol will be attempted. If that is not supported, VXI-11 protocol will be used.
- `iopen("lan:auto[machineName]:hpiB7,1")` will automatically select the protocol (SICL-LAN if available and VXI-11 otherwise.)
- `iopen("lan:sicl-lan[machineName]:hpiB7,1")` will use SICL-LAN protocol.
- `iopen("lan:vxi-11[machineName]:hpiB7,1")` will use VXI-11 protocol.

The LAN Client also supports TCP/IP socket reads and writes. To open a socket session, use `iopen("lan,socketNbr[machineName]")`. For example, `iopen("lan,7777[machineName]")` will open a socket connection for socket number 7777 on 'machineName'.

When you have configured VISA LAN Client interfaces, you can then use the interface name specified during configuration in a VISA `viOpen` call of your program. However, the LAN server does *not* support simultaneous connections from LAN clients using the SICL-LAN Protocol and from LAN clients using VXI-11 (TCP/IP Instrument Protocol).

There are three LAN servers that can be used with VISA and SICL: the E2050 LAN/GPIB Gateway, an HP Series 700 computer running HP-UX, or a PC running Windows 95/98/Me/2000/NT. To use this capability, the LAN server must have a local GPIB interface configured for I/O.

## Configuring LAN Client Interfaces

An **IO interface** can be defined as both a hardware interface and as a software interface. The purpose of the IO Config utility is to associate a unique interface name with a hardware interface.

The IO Libraries use an **Interface Name** or **Logical Unit Number** to identify an interface. This information is passed in the parameter string of the **viOpen** function call in a VISA program or in the **iopen** function call in a SIDL program. IO Config assigns an Interface Name and Logical Unit Number to the interface hardware, as well as other necessary configuration values for an interface when the interface is configured.

Using IO Config to  
Configure LAN  
Client Interfaces

To configure LAN Client interfaces using the IO Config utility, click the Agilent IO Libraries Control icon (blue icon on the Windows taskbar) and click **Run IO Config**. When the main screen appears, highlight the **TCPIP LAN Client (LAN Instruments)** menu item (see the following figure) and click the **Configure** button.

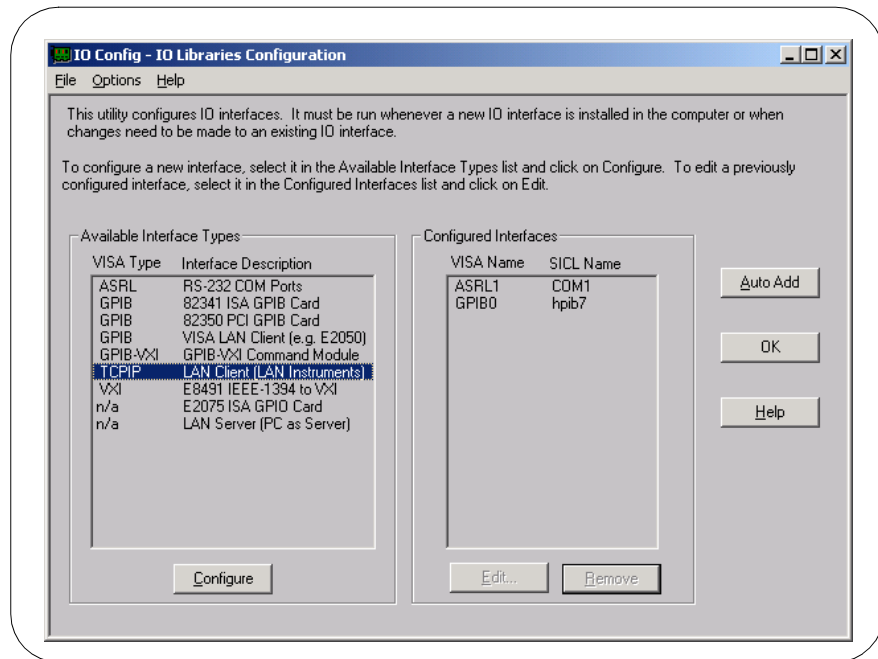

When the **LAN Client** screen appears, set the VISA Interface Name and Logical Unit number, as required. Also, you can select the Default Protocol (AUTO, VXI-11, or SICL-LAN) and choose whether or not to Log Errors. Then, click the **OK** button.

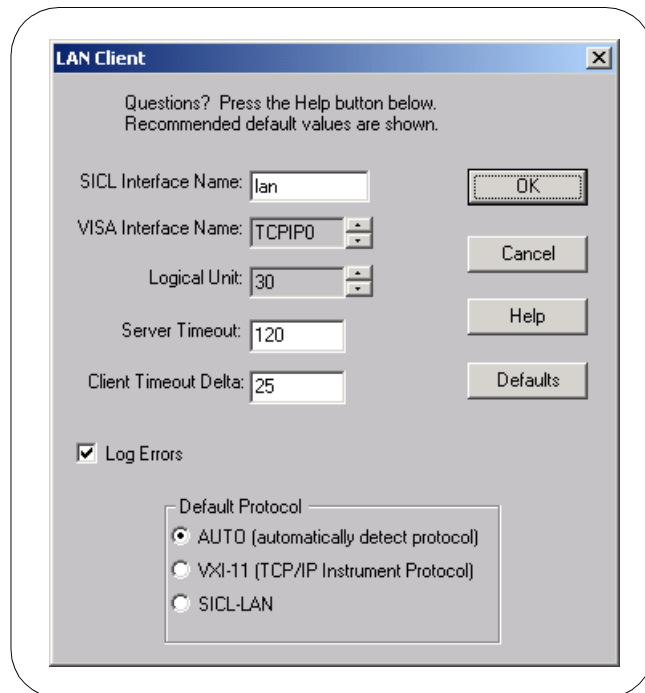

**NOTE**

After the system is configured, this screen may also display an **Edit VISA Config...** button. Clicking this button allows you to manually configure the interface as desired. See the IO Libraries Readme file for details.

## Configuring I/O Interfaces

### Configuring LAN Interfaces

#### Example: Configuring LAN Client (Gateway) Interface

The LAN Client interface system in the following figure consists of a Windows PC with a LAN card, an E2050 LAN/GPIB gateway, and two GPIB instruments. For this system, the IO Config utility has been used to assign the LAN card a VISA name of "TCPIP0" and SICL name of "lan".

With these names assigned to the interface, VISA/SICL addressing is as shown in the figure. Since unique names have been assigned by IO Config, you can now use the VISA `viOpen` command or the SICL `iopen` command to open the IO paths to the GPIB instruments as shown in the figure.

See the *Agilent VISA User's Guide* for details on VISA commands. See the *Agilent SICL User's Guide for Windows* for details on SICL commands.

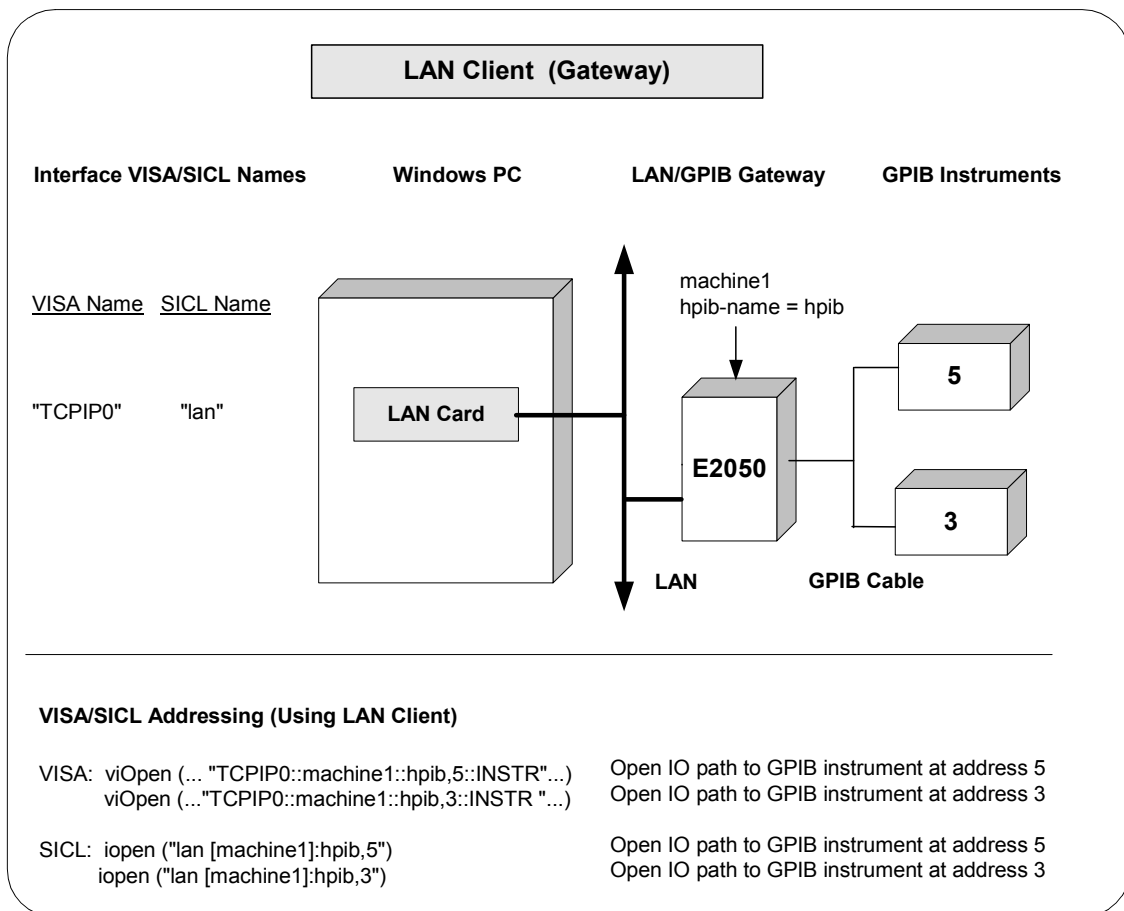

**Example:  
 Configuring LAN  
 Client (LAN)  
 Interface**

The LAN Client interface system in the following figure consists of a Windows PC with a LAN card and three LAN instruments. Instrument1 and instrument2 are VXI-11.2 (GPIB Emulation) instruments and instrument3 is a VXI-11.3 LAN instrument.

For this system, the IO Config utility has been used to assign the LAN card a VISA name of "TCPIP0" and SICL name of "lan". For the addressing examples, instrument1 has been addressed by its machine name, instrument 2 has been addressed by its IP address, and instrument3 by its LAN name (inst0).

Since unique names have been assigned by IO Config, you can now use the VISA `viOpen` command or the SICL `iopen` command to open the I/O paths to the GPIB instruments as shown in the figure. See the *Agilent VISA User's Guide* for details on VISA commands. See the *Agilent SICL User's Guide* for details on SICL commands.

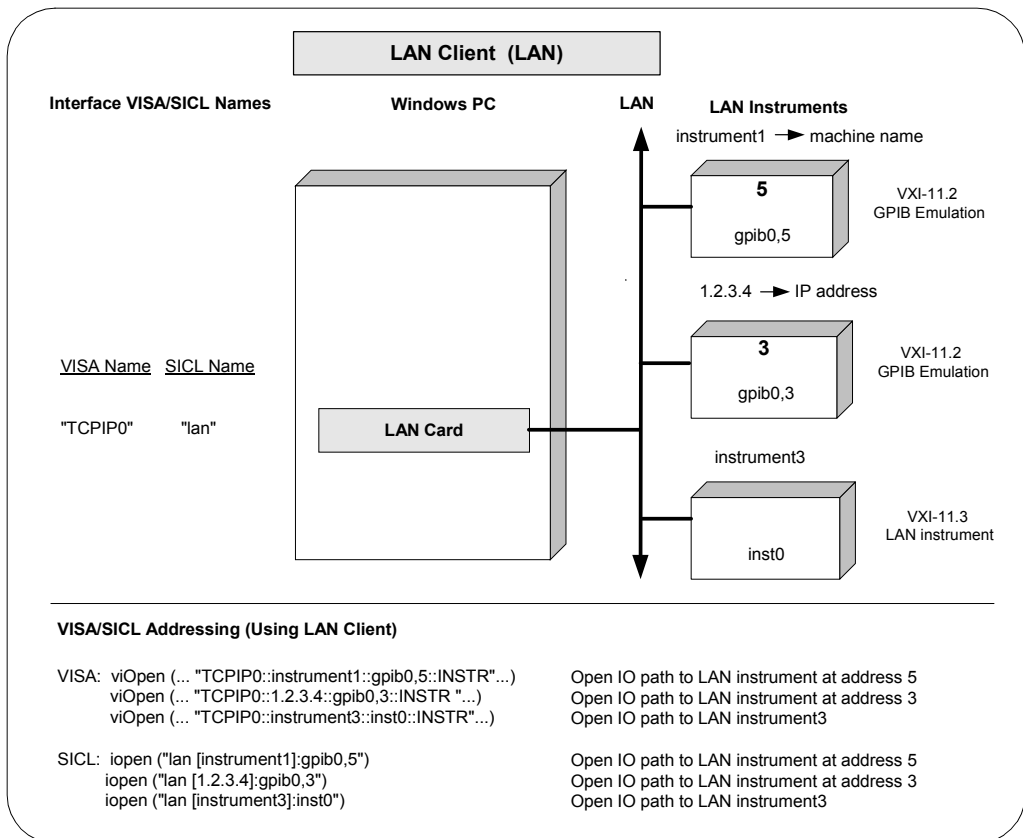

## Configuring VISA LAN Client Interfaces

An **IO interface** can be defined as both a hardware interface and as a software interface. The purpose of the IO Config utility is to associate a unique interface name with a hardware interface.

The IO Libraries use an **Interface Name** or **Logical Unit Number** to identify an interface. This information is passed in the parameter string of the **viOpen** function call in a VISA program or in the **iOpen** function call in a SICL program. IO Config assigns an Interface Name and Logical Unit Number to the interface hardware, as well as other necessary configuration values for an interface when the interface is configured.

### NOTE

You must install a LAN Client interface BEFORE you can use a VISA LAN Client interface. See “Configuring LAN Client Interfaces” for details on configuring LAN Client interfaces.

### Using IO Config to Configure VISA LAN Client Interfaces

To configure VISA LAN Client interfaces using the IO Config utility, click the Agilent IO Libraries Control icon (blue icon on the Windows taskbar) and click **Run IO Config**. When the main screen appears, highlight the **GPIB VISA LAN Client (e.g. 2050)** menu item (see the following figure) and click the **Configure** button.

When the **VISA LAN Client Interface (LAN to GPIB)** screen appears, set the VISA Interface Name and LAN Client SICL Interface Name, as required. Then, click the **OK** button.

### NOTE

After the system is configured, the **VISA LAN Client Interface (LAN to GPIB)** screen may also display an **Edit VISA Config...** button. Clicking this button allows you to manually configure the interface as desired. See the *IO Libraries Readme* file for details.

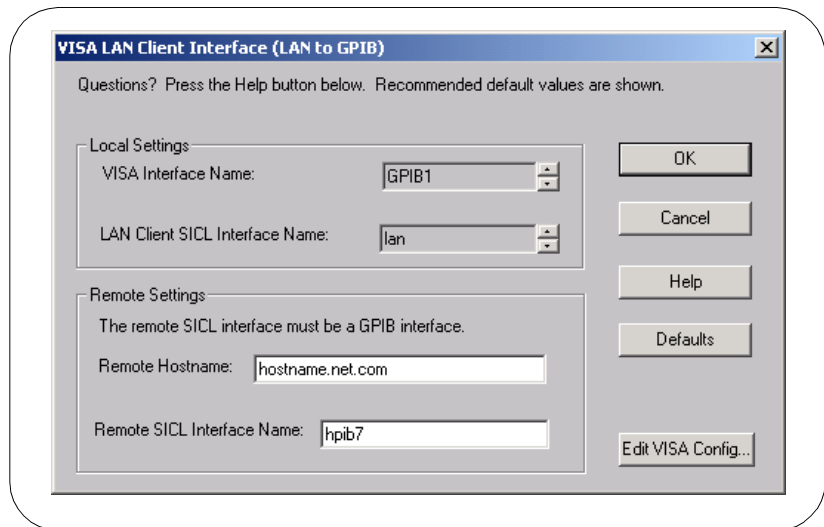
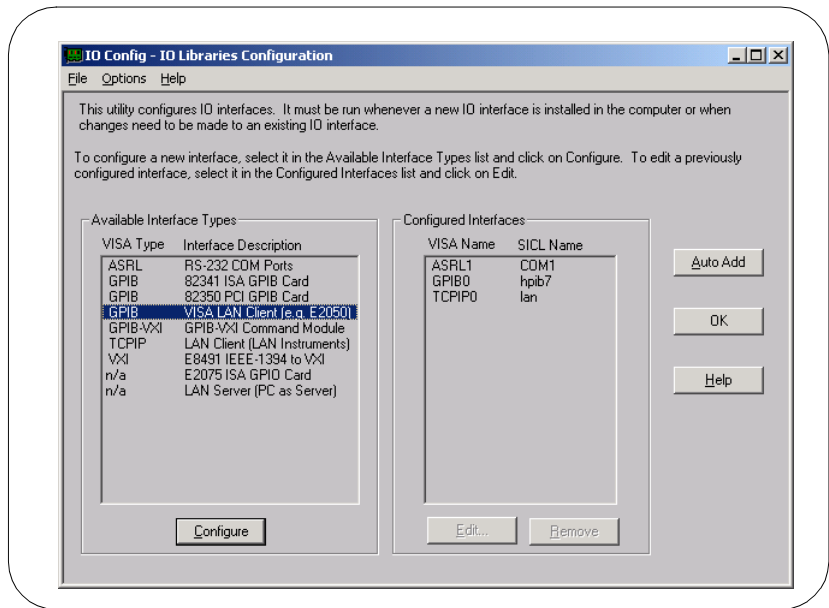

## Configuring LAN Interfaces

### Example: Configuring VISA LAN Client (Gateway) Interface

The VISA LAN Client interface system in the following figure consists of a Windows PC with a LAN card, an E2050 LAN/GPIB gateway, and two GPIB instruments. The IO Config utility has been used to assign the LAN card a VISA name of "TCPIP0" and SICL name of "lan". In addition, a VISA LAN Client has been configured with the interface names and host names shown in the figure. Also, the E2050 LAN/GPIB Gateway has been assigned a name of machine1 and an hpib-name = hpib.

Since unique names have been assigned by IO Config, you can now use the VISA `viOpen` command or the SICL `iopen` command to open the IO paths to the GPIB instruments as shown in the figure. Note, however, that SICL addressing is not supported when using VISA LAN Client. See the *Agilent VISA User's Guide* for details on VISA commands. See the *Agilent SICL User's Guide for Windows* for details on SICL commands



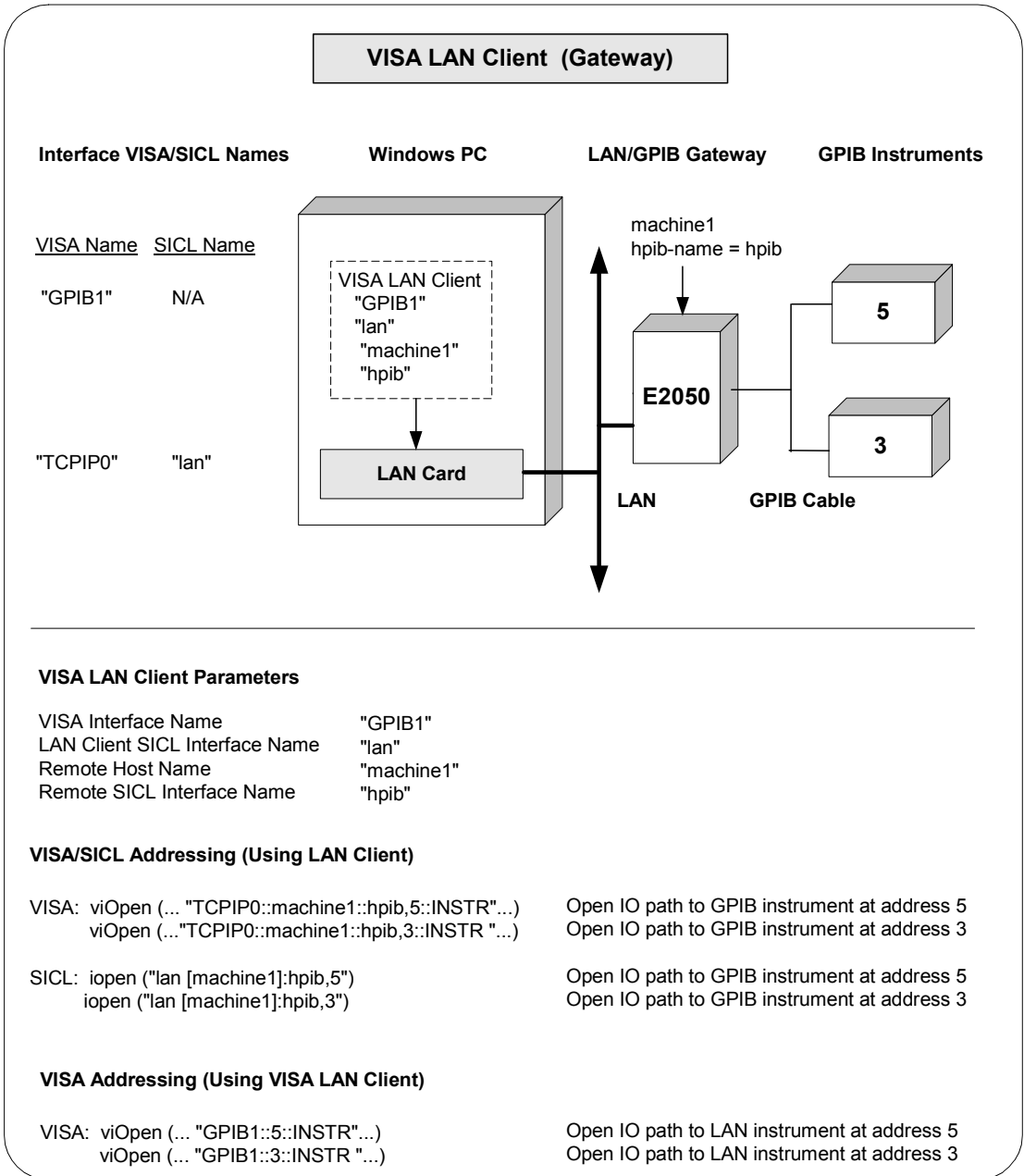

## Configuring LAN Interfaces

### Example: Configuring VISA LAN Client (LAN) Interface

The VISA LAN Client interface system in the following figure consists of a Windows PC with a LAN card and three LAN instruments. Instrument1 and instrument2 are VXI-11.2 (GPIB Emulation) instruments and instrument3 is a VXI-11.3 LAN instrument.

For this system, the IO Config utility has been used to assign the LAN card a VISA name of “TCPIP0” and SICL name of “lan”. In addition, two VISA LAN Clients have been configured with the interface names and host names shown in the figure.

For the addressing examples, instrument1 has been addressed by its machine name, instrument 2 has been addressed by its IP address, and instrument3 by its LAN name (inst0).

Since unique names have been assigned by IO Config, you can now use the VISA `viOpen` command or the SICL `iOpen` command to open the IO paths to the GPIB instruments as shown in the figure. Note, however, that you cannot talk to instrument3 with VISA LAN Client. You must use the LAN Client (with VISA or SICL) to talk to instrument3, since instrument3 is not a remote gpib interface.

#### NOTE

When using the VXI-11 protocol with VISA LAN Client, the Remote SICL Interface Name must be of the form `gpibN` where `N` is 0 or a positive integer. This restriction does not apply to the SICL-LAN protocol.

See the *Agilent VISA User's Guide* for details on VISA commands. See the *Agilent SICL User's Guide for Windows* for details on SICL commands.

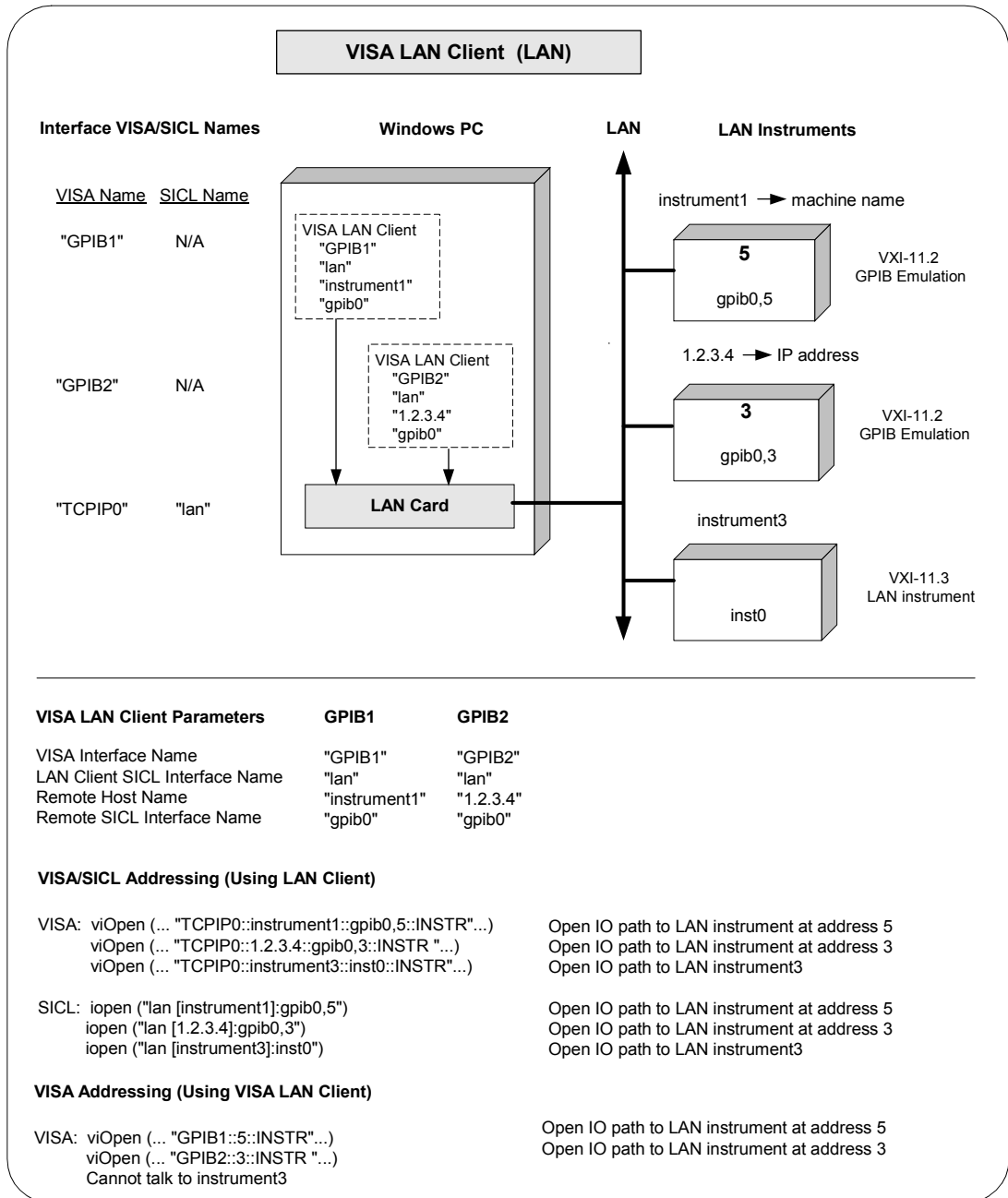

## Configuring LAN Server Interfaces

An **IO interface** can be defined as both a hardware interface and as a software interface. The purpose of the IO Config utility is to associate a unique interface name with a hardware interface.

The IO Libraries use an **Interface Name** or **Logical Unit Number** to identify an interface. This information is passed in the parameter string of the **viOpen** function call in a VISA program or in the **iOpen** function call in a SICL program. IO Config assigns an Interface Name and Logical Unit Number to the interface hardware, as well as other necessary configuration values for an interface when the interface is configured.

### NOTE

The LAN Server supports both VXI-11 and SICL-LAN protocol.

Using IO Config to  
Configure VISA LAN  
Server Interface

To configure VISA LAN Server interfaces using the IO Config utility, click the Agilent IO Libraries Control icon (blue icon on the Windows taskbar) and click **Run IO Config**. When the main screen appears, highlight the **n/a LAN Server (PC as Server)** menu item (see the following figure) and click the **Configure** button.

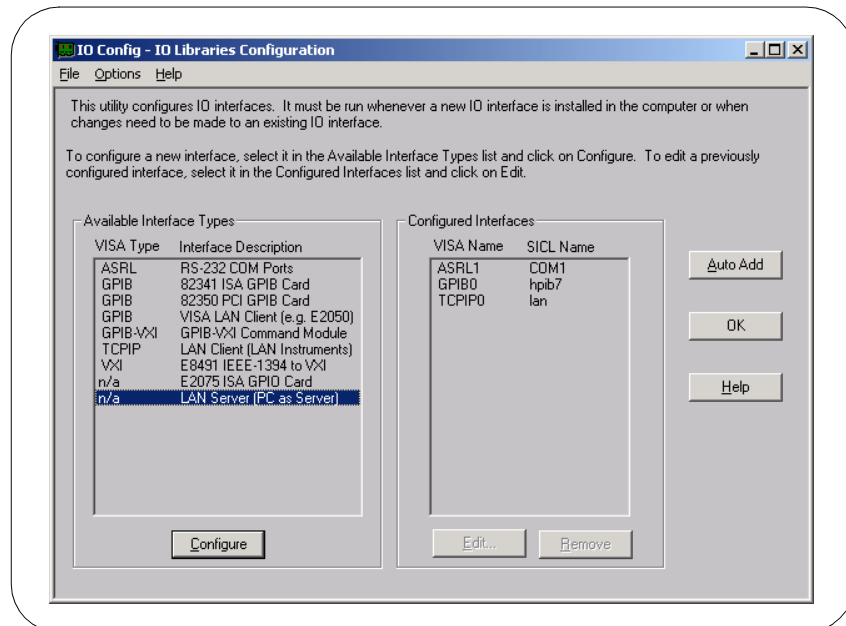

When the **Agilent LAN Server** screen appears, set the Server Timeout as required. Also, as required, set Log Errors, Log Locks and Connections and/or Use Keepalive Client Probes. Then, click the **OK** button.

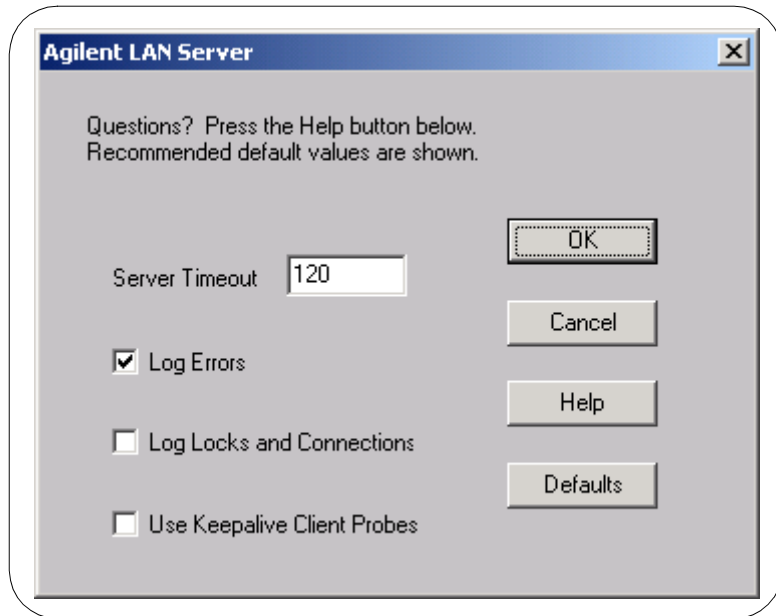

**Example:**  
Configuring LAN  
Server Interface

The LAN Server interface system in the following figure consists of a Windows PC acting as a LAN client, a second PC acting as a LAN server, and a GPIB instrument. The IO Config utility has been used to assign the LAN card a VISA name of "TCPIP0" and SICL name of "lan". Also, the GPIB card in the LAN server PC has been assigned VISA name of "GPIB0" and SICL name of "hpib7". The LAN server PC has been assigned a name of machine2.

Since unique names have been assigned by IO Config, you can now use the VISA `viOpen` command or the SICL `iopen` command to open the IO paths to the GPIB instruments as shown in the figure. See the *Agilent VISA User's Guide* for details on VISA commands. See the *Agilent SICL User's Guide* for details on SICL commands.

# Configuring I/O Interfaces

## Configuring LAN Interfaces

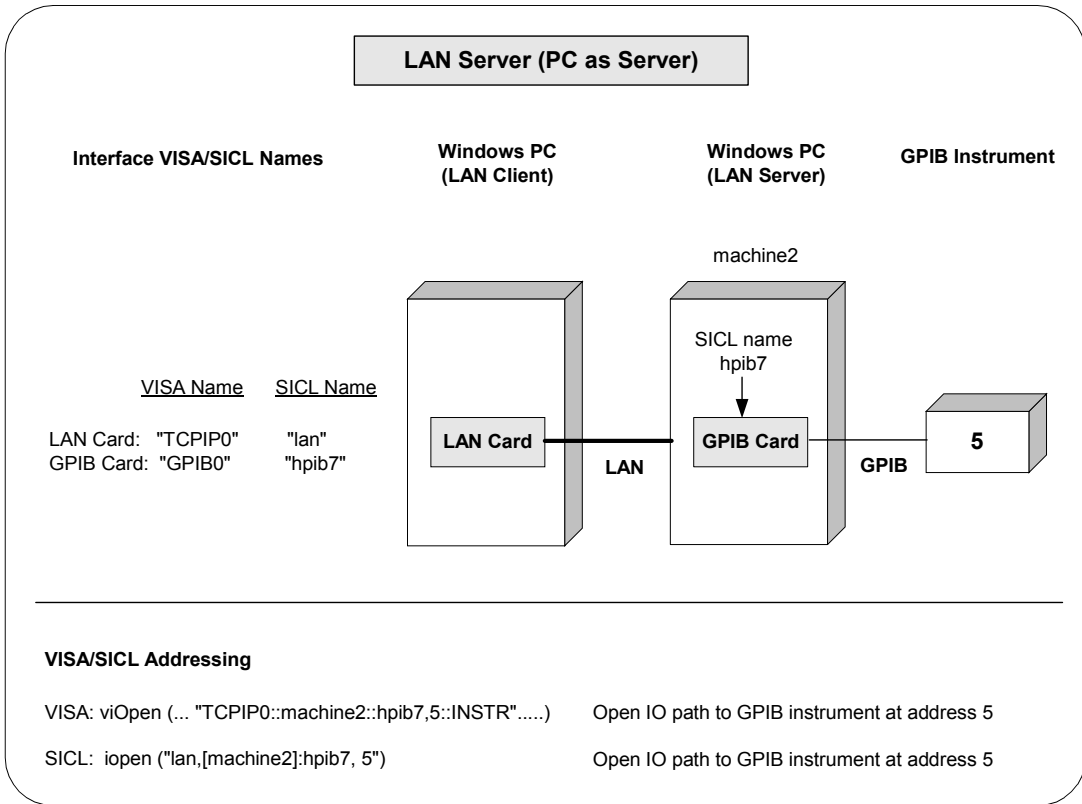

---

## Configuring Other Interfaces

This section gives guidelines to use the IO Config utility to configure ASRL (RS-232) and GPIO interfaces, including:

- ASRL and GPIO Interfaces Overview
- Configuring ASRL Interfaces
- Configuring GPIO Interfaces

### ASRL and GPIO Interface Overview

As shown in the following figure, a typical ASRL (RS-232) interface consists of a Windows PC with one or more RS-232 COM Ports. Each COM port can be connected to one, and only one, Serial instrument via an RS-232 cable. A typical GPIO interface consists of a Windows PC with an E2075A GPIO card that is connected to a GPIO instrument via a GPIO cable.

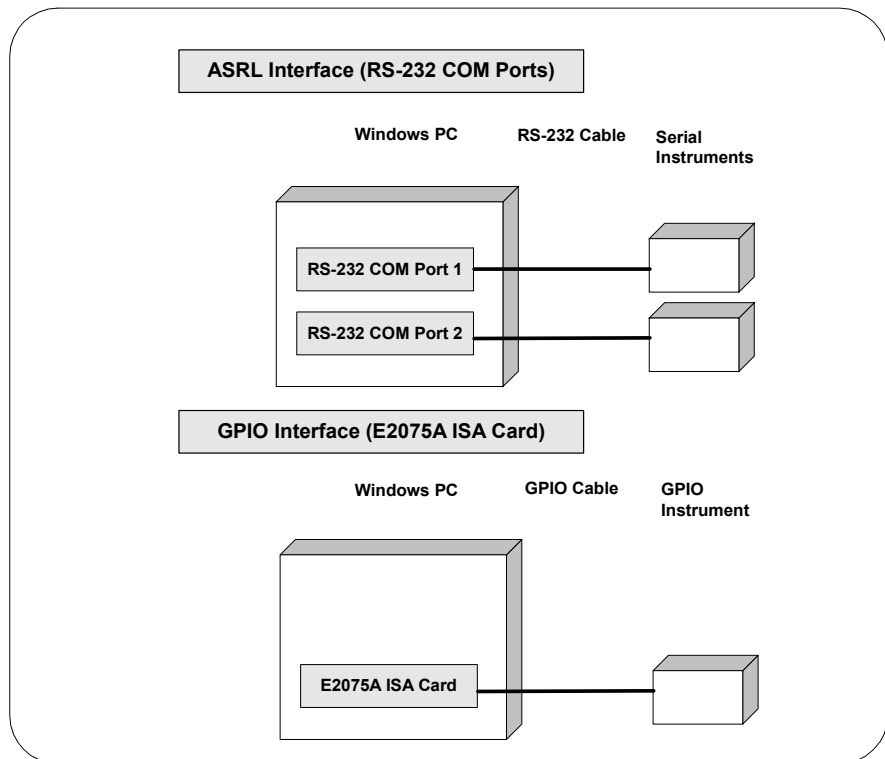

## Configuring ASRL Interfaces

An **IO interface** can be defined as both a hardware interface and as a software interface. The purpose of the IO Config utility is to associate a unique interface name with a hardware interface.

The IO Libraries use an **Interface Name** or **Logical Unit Number** to identify an interface. This information is passed in the parameter string of the **viOpen** function call in a VISA program or in the **iOpen** function call in a SICL program. IO Config assigns an Interface Name and Logical Unit Number to the interface hardware, as well as other necessary configuration values for an interface when the interface is configured.

Using IO Config to  
Configure ASRL  
Interfaces

To configure ASRL interfaces using the IO Config utility, click the Agilent IO Libraries Control icon (blue icon on the Windows taskbar) and click **Run IO Config**. When the main screen appears, highlight the **ASRL RS-232 COM Ports** menu item (see the following figure) and click the **Configure** button.

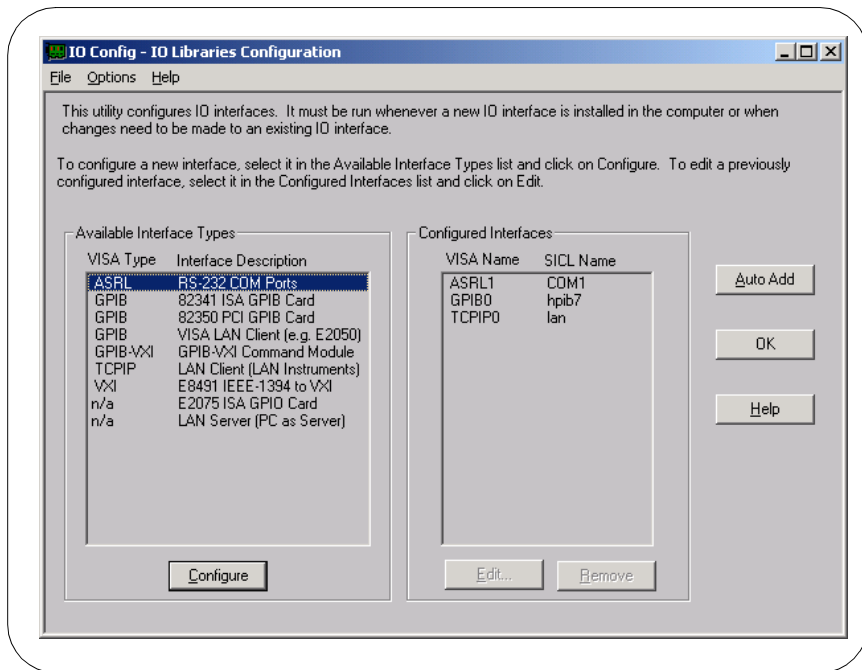



When the **RS-232 COM Ports** screen appears, set the VISA Interface Name and Serial port attributes, as required. Then, click the **OK** button.

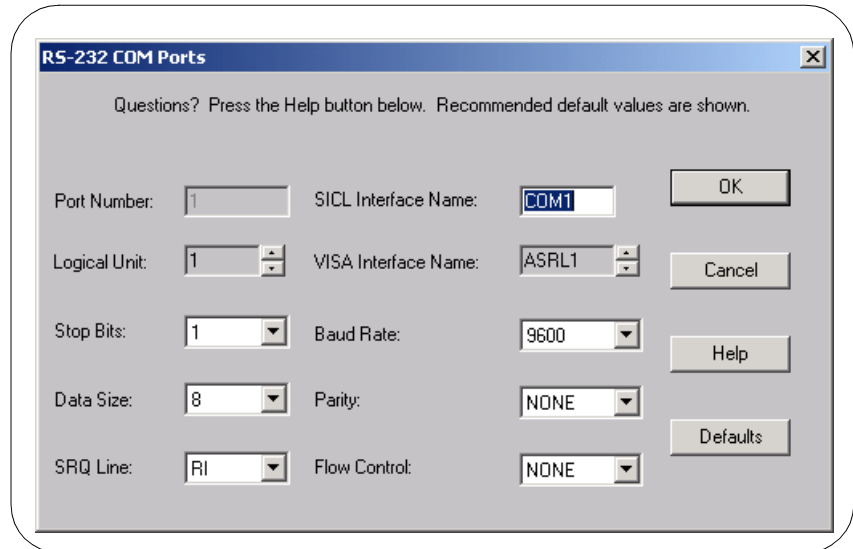

**Example:**  
Configuring ASRL  
Interfaces

The ASRL interface system in the following figure consists of a Windows PC with two RS-232 COM ports, each of which is connected to a single Serial instrument via RS-232 cables. The IO Config utility has been used to assign COM Port 1 a VISA name of "ASRL1" and SICL name of "COM1". The IO Config utility has been used to assign COM Port 2 a VISA name of "ASRL2" and SICL name of "COM2".

Since unique names have been assigned by IO Config, you can now use the VISA `viOpen` command to open the IO paths to the GPIB instruments as shown in the figure. See the *Agilent VISA User's Guide* for details on VISA commands. See the *Agilent SICL User's Guide for Windows* for details on SICL commands.

## Configuring I/O Interfaces

### Configuring Other Interfaces

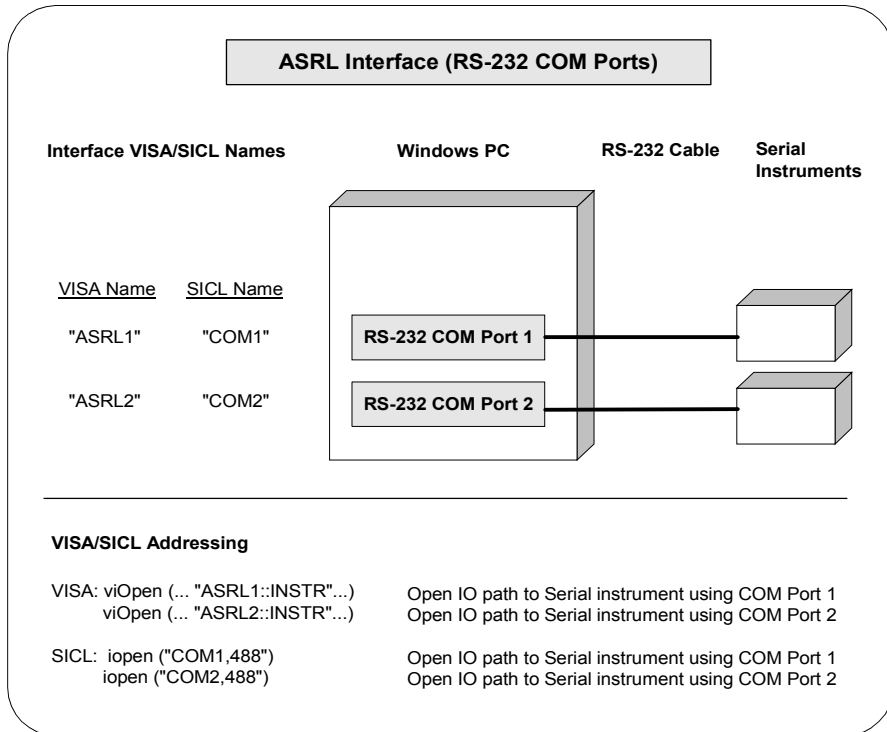

## Configuring GPIO Interfaces

An **IO interface** can be defined as both a hardware interface and as a software interface. The purpose of the IO Config utility is to associate a unique interface name with a hardware interface.

The IO Libraries use an **Interface Name** or **Logical Unit Number** to identify an interface. This information is passed in the parameter string in the **ioopen** function call in a SICL program. IO Config assigns an Interface Name and Logical Unit Number to the interface hardware, as well as other necessary configuration values for an interface when the interface is configured.

Using IO Config to  
Configure GPIO  
Interfaces

To configure GPIO interfaces using the IO Config utility, click the Agilent IO Libraries Control icon (blue icon on the Windows taskbar) and click **Run IO Config**. When the main screen appears, highlight the **n/a E2075A ISA GPIO Card** menu item (see the following figure) and click the **Configure** button.

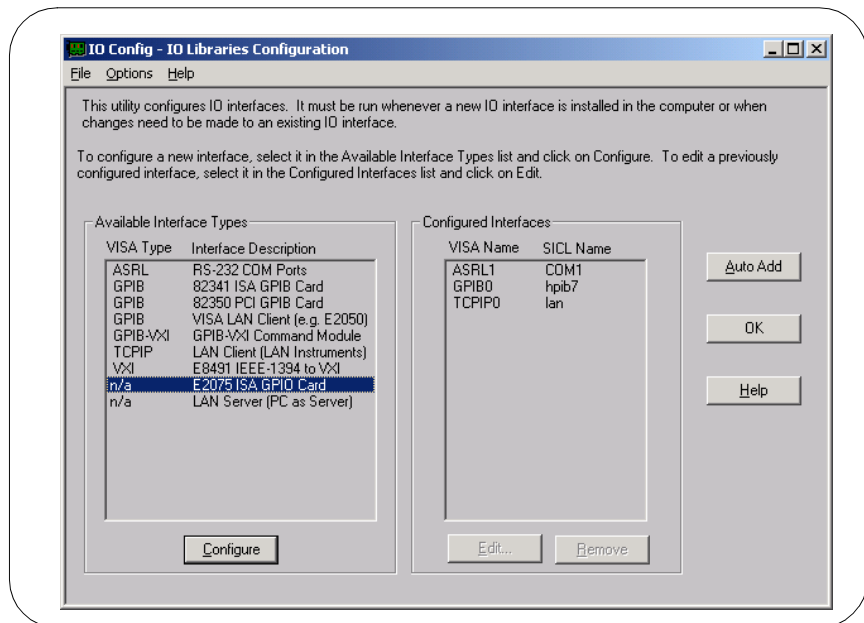

## Configuring I/O Interfaces

### Configuring Other Interfaces

When the **E2075 ISA GPIO Card Configuration** screen appears, set the attributes as desired. Then, click the **OK** button.

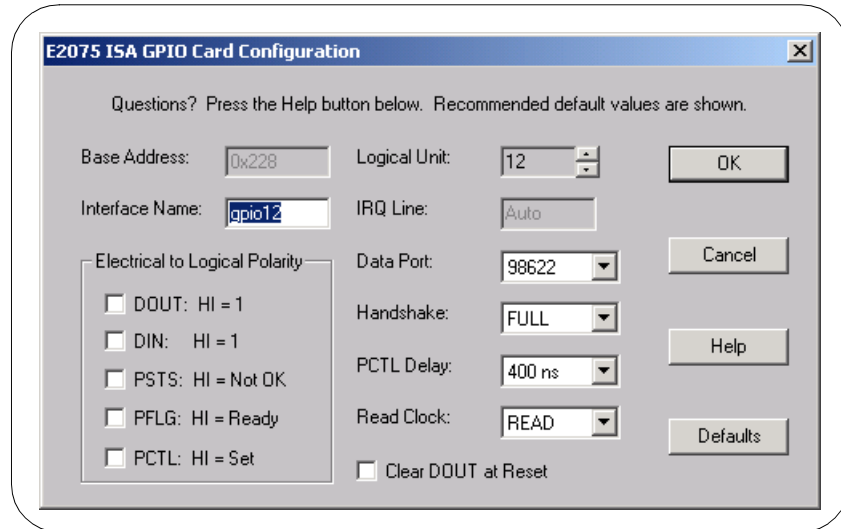

The screenshot shows the "E2075 ISA GPIO Card Configuration" dialog box. It contains the following fields and controls:

- Base Address:
- Logical Unit:
- Interface Name:
- IRQ Line:
- Data Port:
- Handshake:
- PCTL Delay:
- Read Clock:
- Clear DOUT at Reset:
- Electrical to Logical Polarity section with checkboxes:
  - DOUT: HI = 1
  - DIN: HI = 1
  - PSTS: HI = Not OK
  - PFLG: HI = Ready
  - PCTL: HI = Set
- Buttons: OK, Cancel, Help, Defaults

#### Example: Configuring GPIO Interfaces

The GPIO interface system in the following figure consists of a Windows PC with an E2075A GPIO card that is connected to a GPIO instrument via GPIO cable.

The IO Config utility has been used to assign the E2075A GPIO card a SICL name of "gpio12". (GPIO is NOT supported by VISA.) Since unique names have been assigned by IO Config, you can now use the SICL `iopen` command to open the I/O paths to the GPIB instruments as shown in the figure. See the *Agilent SICL User's Guide for Windows* for details on SICL commands.

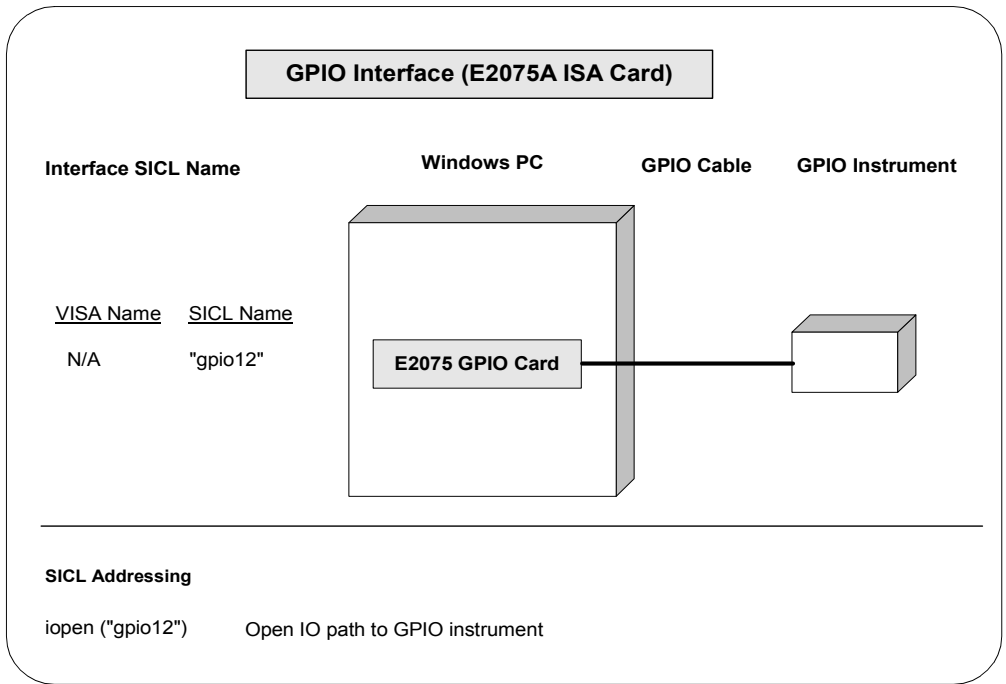

**Notes:**

---

## A

- Agilent telephone numbers, 9
- Agilent web site, 9
- ASRL interfaces
  - configuring, 104
  - overview, 103

## C

- configuring GPIB interfaces, 71
- configuring I/O interfaces, 70
- configuring LAN interfaces, 85
- configuring VXI interfaces, 78
- copyright information, 6

## E

- emergency repair disk, 17
- examples
  - Configuring ASRL Interfaces, 105
  - Configuring GPIB (82341) Interface, 76
  - Configuring GPIB (82350) Interface, 73
  - Configuring GPIB-VXI (E1406A) Interface, 81
  - Configuring GPIO Interfaces, 108
  - Configuring LAN Client (Gateway) Interface, 92
  - Configuring LAN Client (LAN) Interface, 93
  - Configuring LAN Server Interface, 101
  - Configuring VISA LAN Client (Gateway) Interface, 96
  - Configuring VISA LAN Client (LAN) Interface, 98
  - Configuring VXI (E8491B) Interfaces, 84
  - Using IO Config to Configure an Interface, 59

## G

- GPIB interfaces
  - configuring, 71
  - configuring 82341 ISA card, 75
  - configuring 82350 PCI card, 72
  - overview, 71
- GPIO interfaces
  - configuring, 107
  - overview, 103

## I

- I/O interfaces, configuring, 70
- installation type, 23, 29
- installing IO Libraries, 15, 21
- introducing IO Libraries, 8
- IO Config
  - requirements, 56
  - running, 57
  - using, 56
- IO Libraries
  - getting started, 17
  - installation type, 23, 29
  - installing, 15
  - installing new, 21
  - introducing, 8
  - IO Libraries Control icon, 33, 42
  - modifying, 45
  - program groups created, 33, 42
  - Readme file, 17
  - readme file, 22, 28, 34, 43
  - removing, 45, 50
  - repairing, 45, 48
  - supported interfaces, 19
  - system requirements, 18
  - upgrading, 36
- IP address, 93

## L

- LAN, client/server model, 85
- LAN Client
  - definition, 85
  - interfaces, 90
- LAN interfaces
  - client/server model, 85
  - configuring, 85
  - configuring LAN Server, 100
  - hardware architecture, 85
  - LAN Client interfaces, 90
  - overview, 85
  - software architecture, 87
  - VISA LAN Client Interfaces, 94
- LAN Server
  - definition, 85
  - using, 67

## M

- modifying IO Libraries, 45

## P

- printing history, 6
- program groups created, 33, 42

## R

- readme file, 22, 28, 34, 43
- removing IO Libraries, 45, 50
- repairing IO Libraries, 45, 48
- restricted rights, 5
- running IO Config, 57

## S

- SICL
  - description, 12
  - documentation, 12
  - support, 12
  - users, 12

## S (continued)

- SICL-LAN protocol, 88
- supported interfaces, 19
- system requirements, 18

## T

- TCP/IP instrument protocol, 88
- telephone numbers, Agilent, 9
- trademark information, 6

## U

- upgrading IO Libraries, 36
- using IO Config, 56
- using this guide, 9

## V

- VISA
  - description, 10
  - documentation, 11
  - support, 10
  - users, 10
- VISA Assistant, using, 61
- VXI interfaces
  - configuring, 78
  - configuring E1406A, 79
  - configuring E8491B, 82
  - overview, 78
- VXI Resource Manager
  - displaying output, 66
  - using, 62
- VXI-11 protocol, 88

## W

- warranty, 5
- web site, Agilent, 9